

Crane Woodworking

MISCELLANEOUS MOULDING PROFILES

As of October 1, 2010
Original Casing Styles
Available

Crane Woodworking 15 Rockland Road South Norwalk, CT 06854

203 852-9229, Fax 203 853-4799, E-fax 203 538-2838

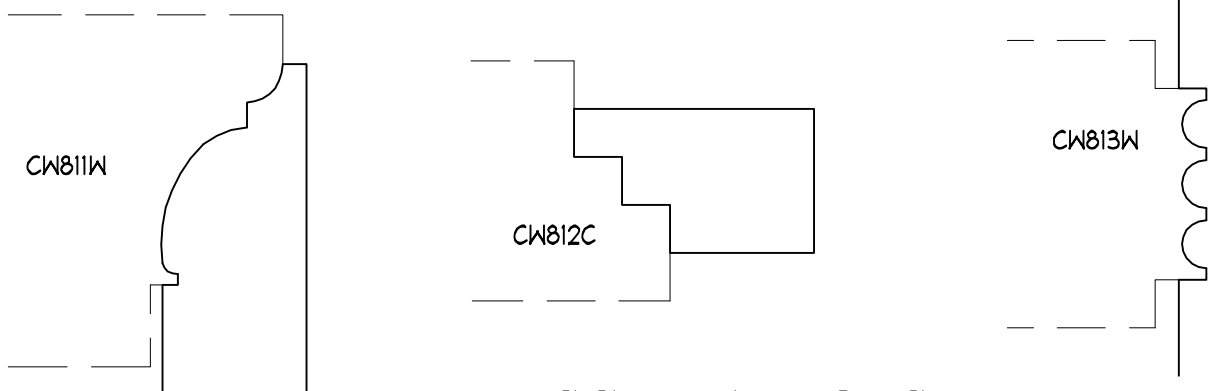
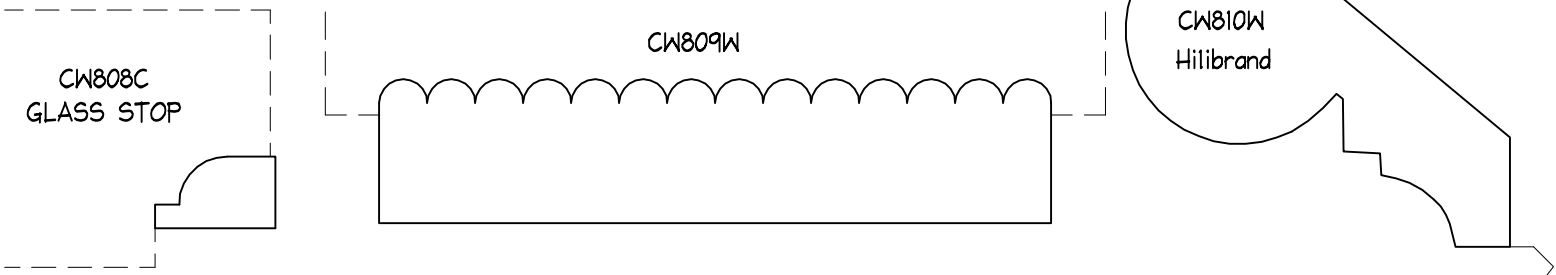
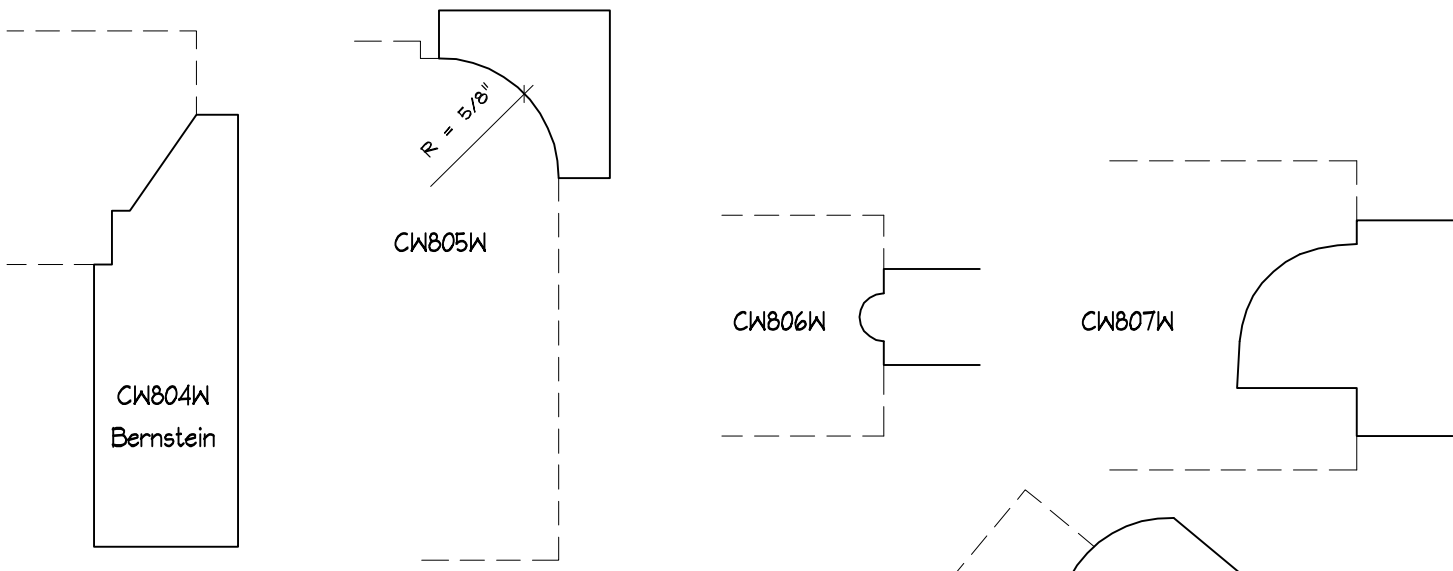
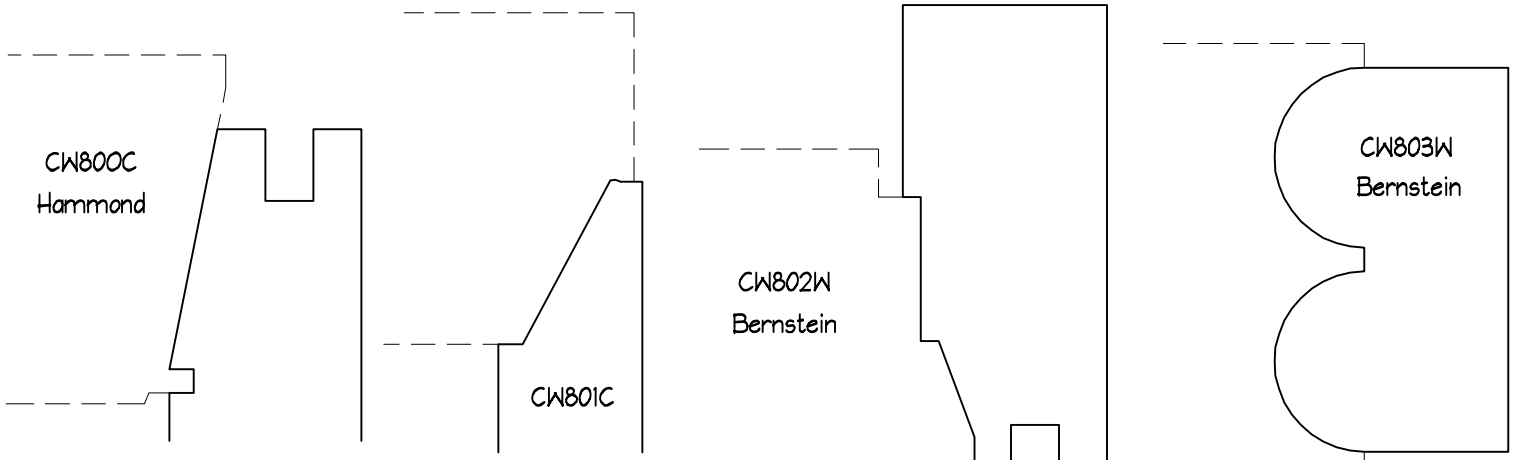

MISCELLANEOUS

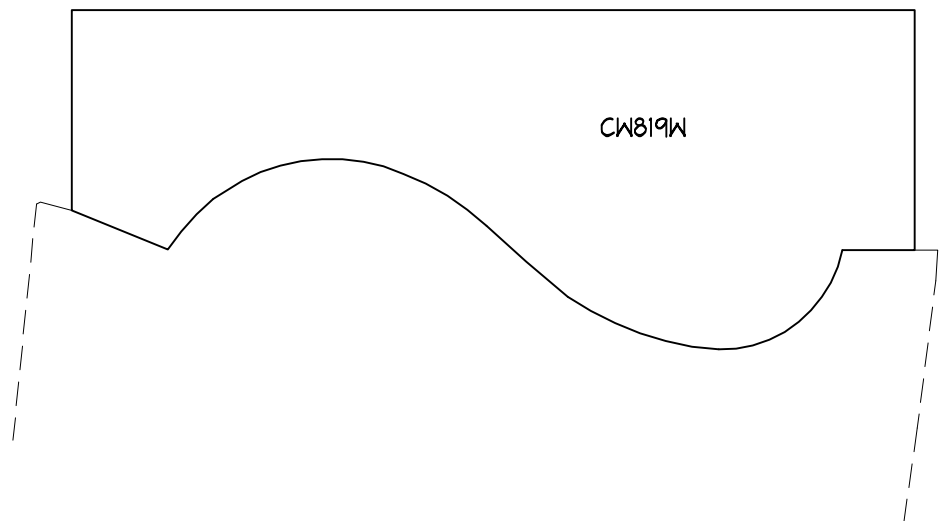
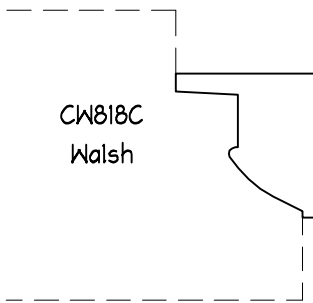
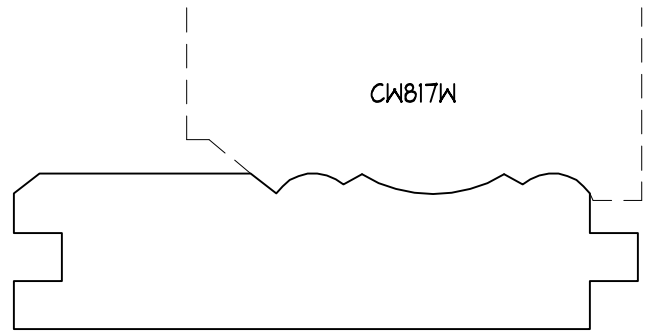
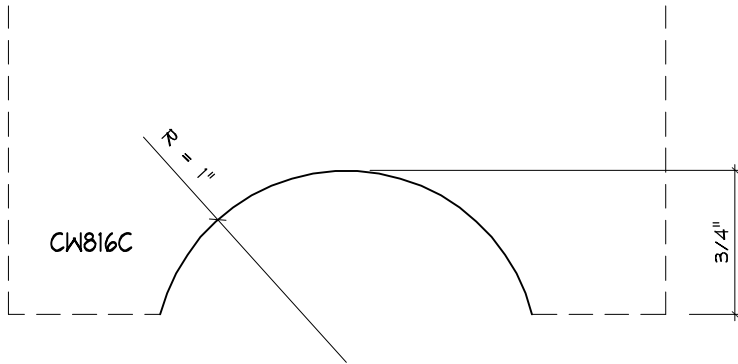
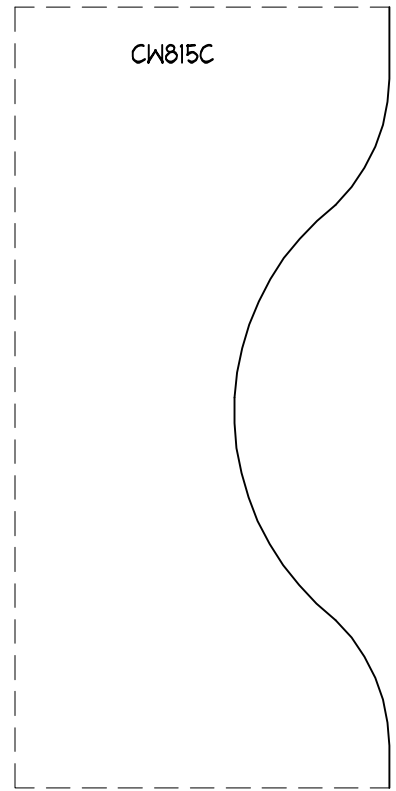
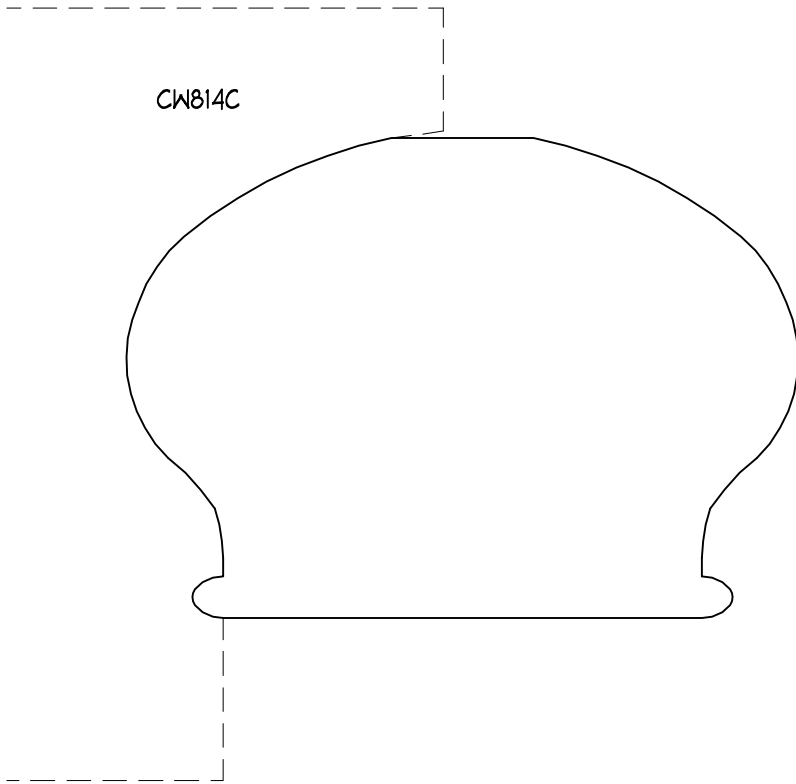

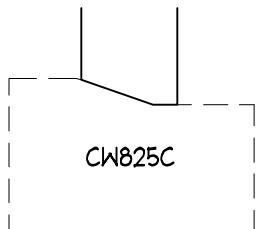
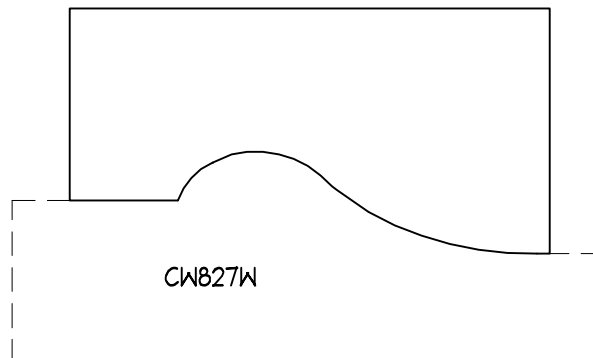
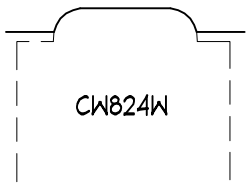
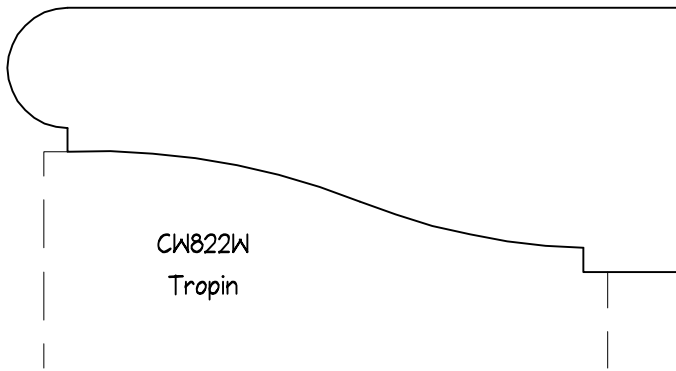
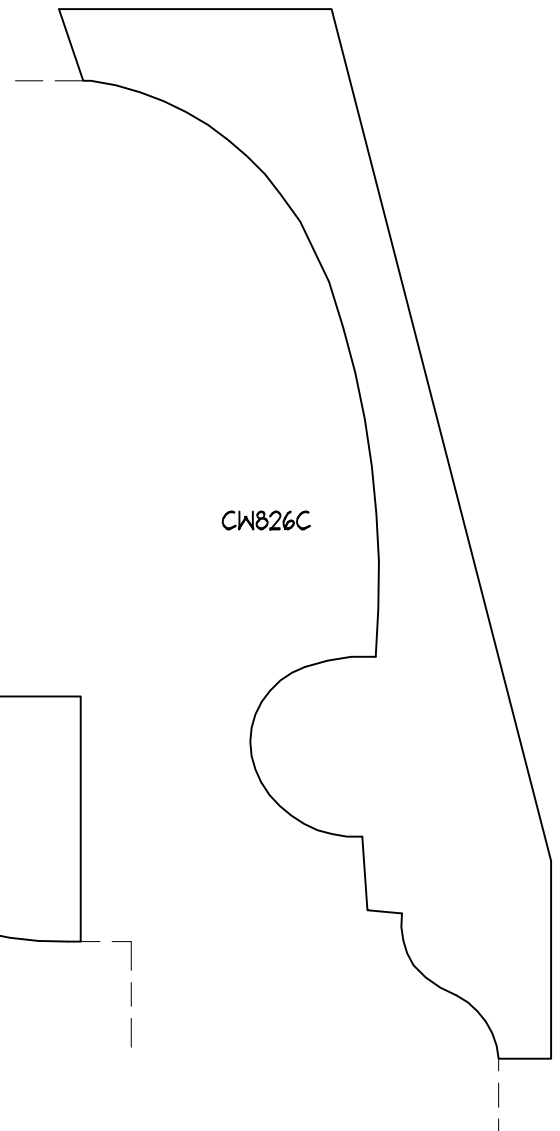
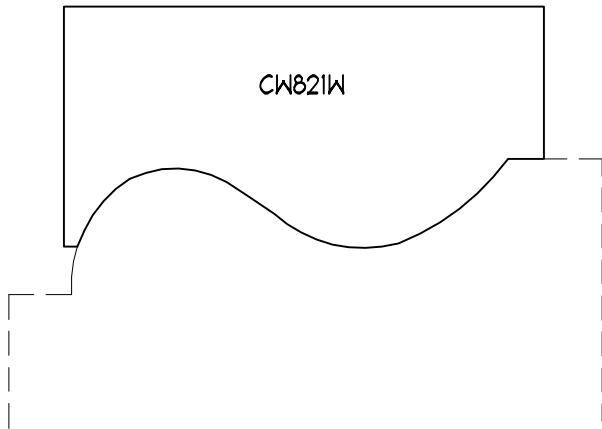
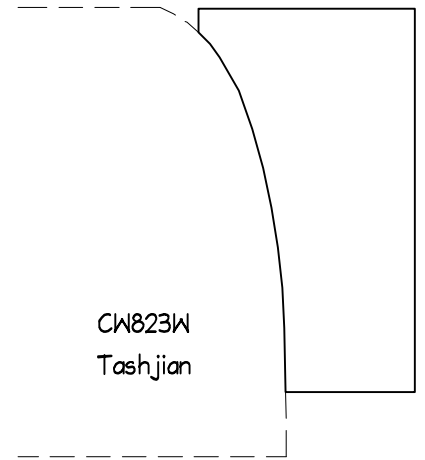
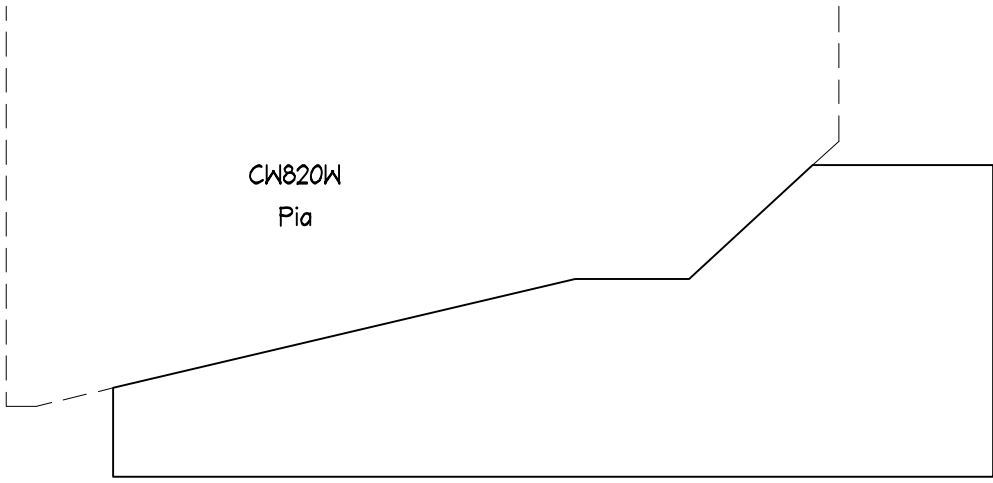

MISCELLANEOUS

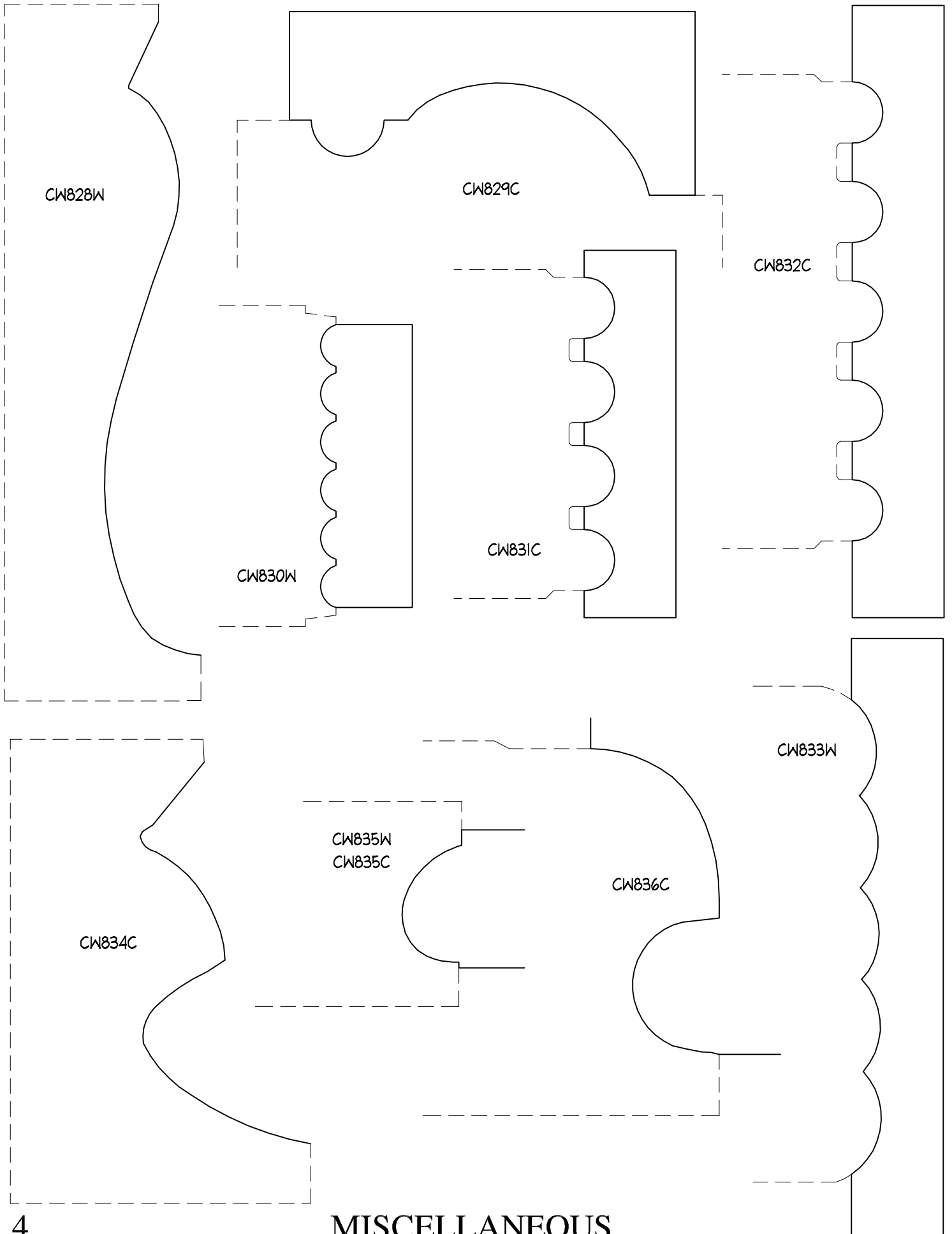

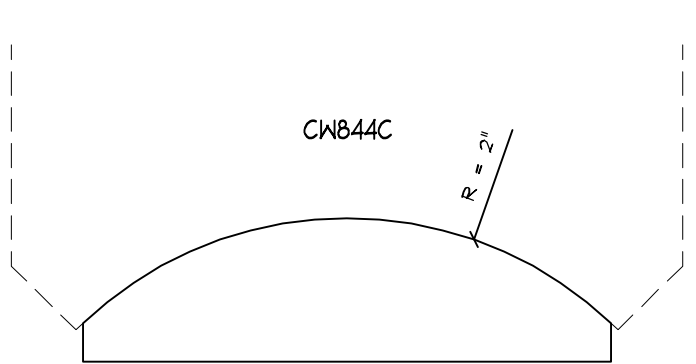
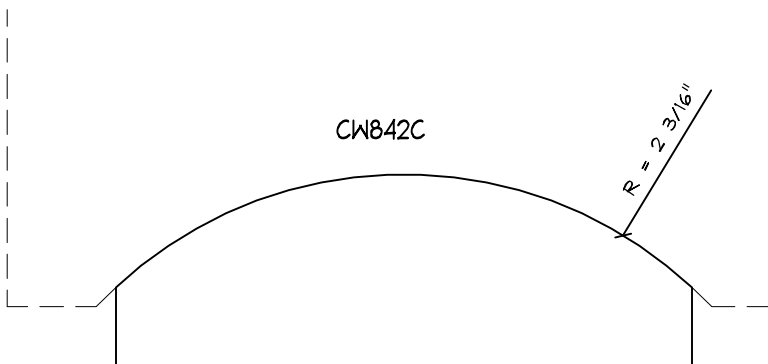
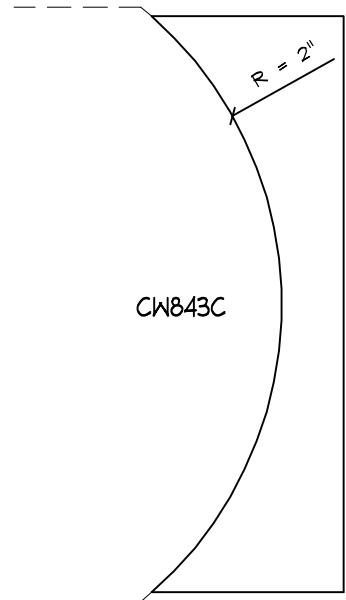
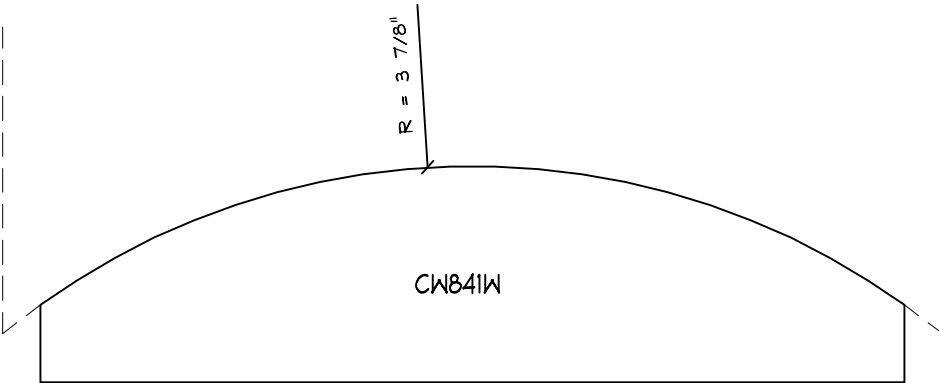
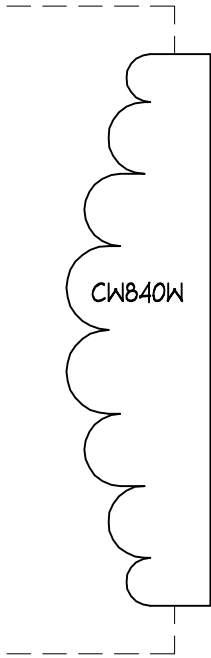
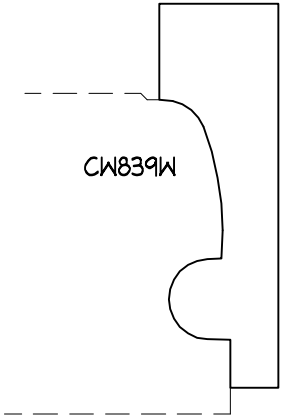
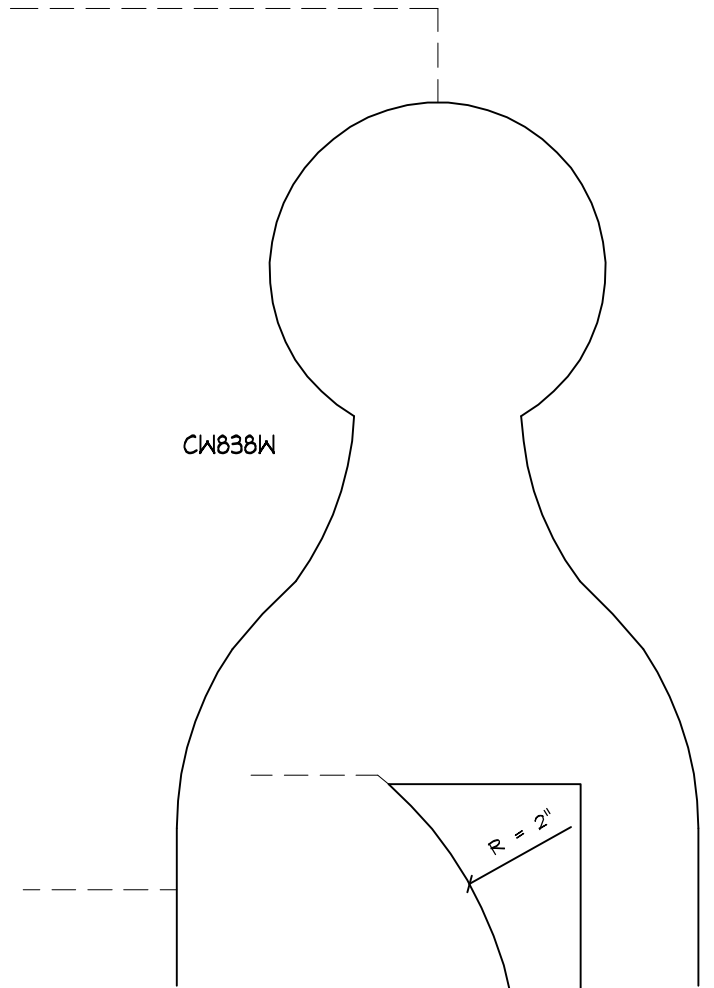
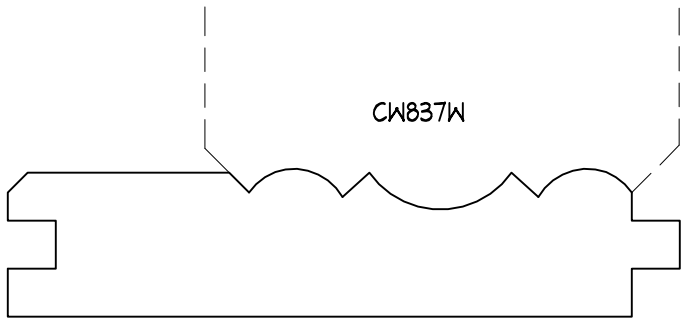

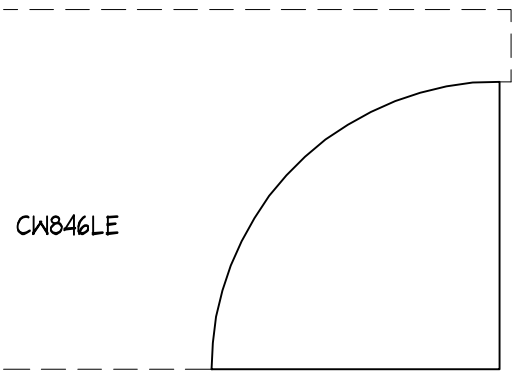

CW846LE

CW846CBM

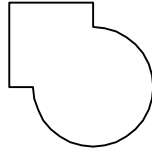

CW845W

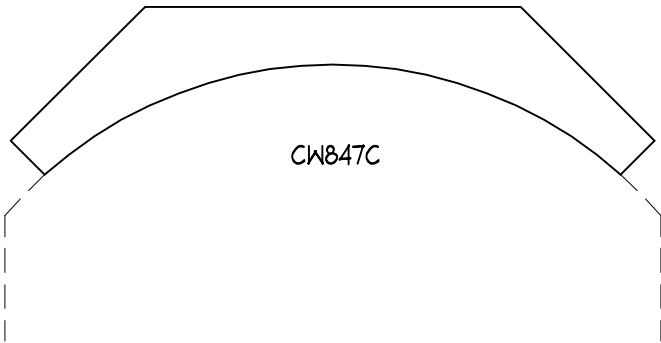
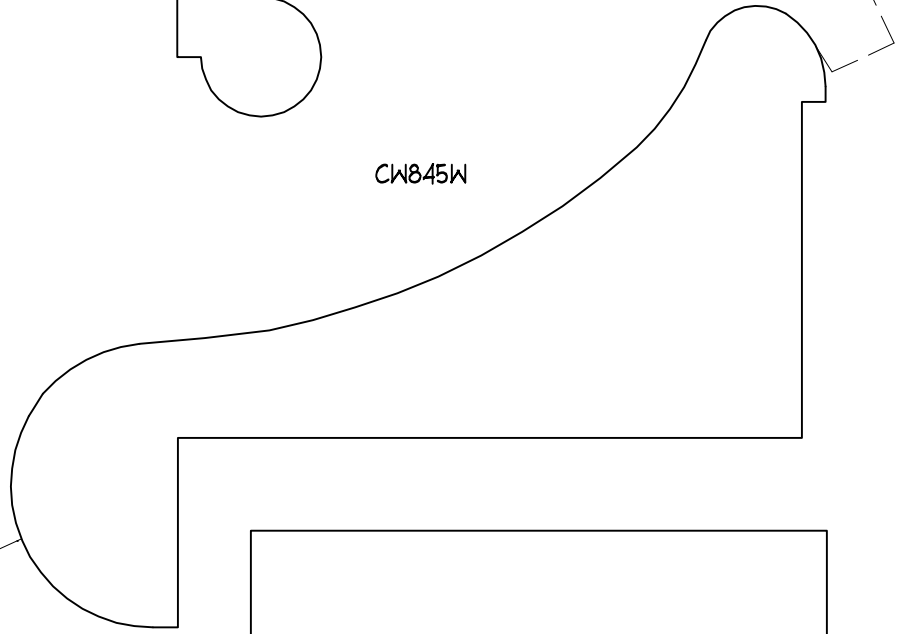

CW847C

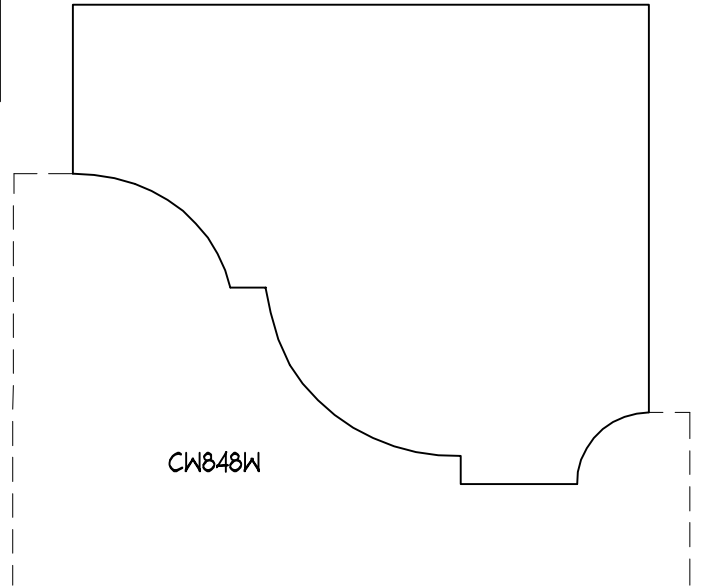

CW848W

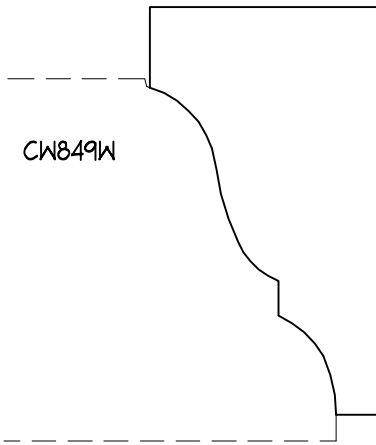

CW849W

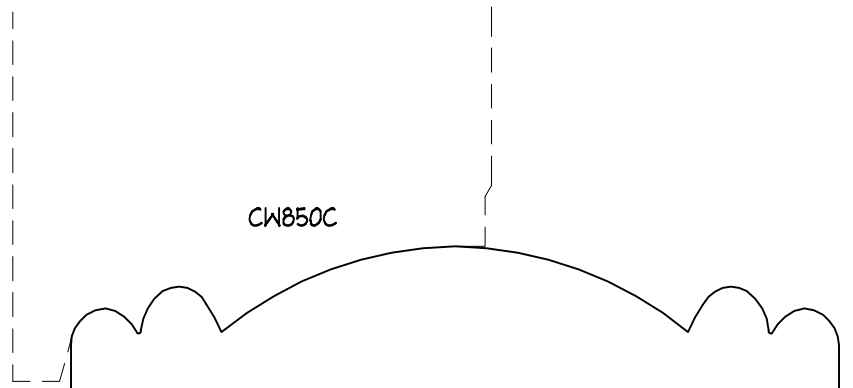

CW850C

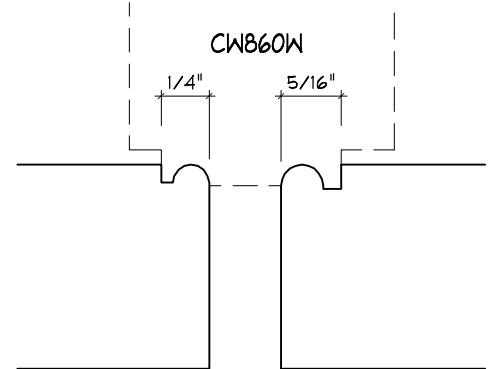
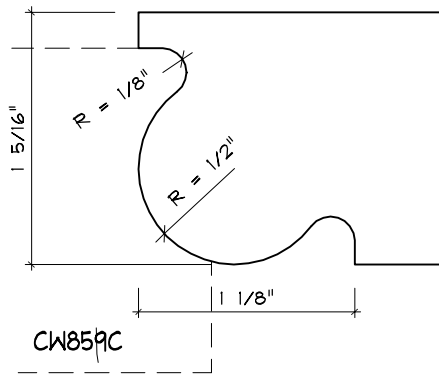
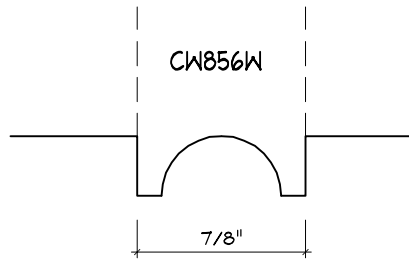
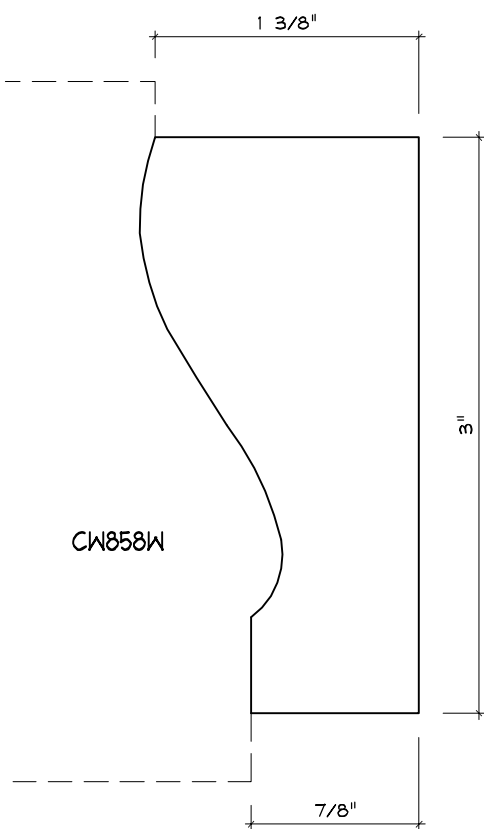
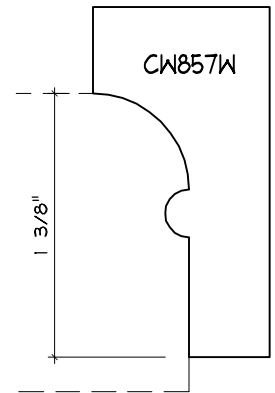
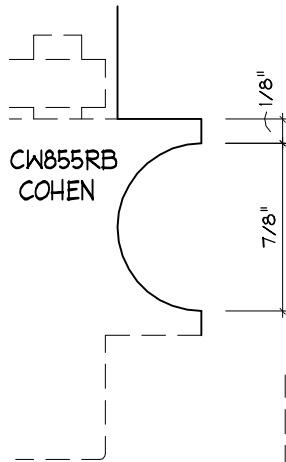
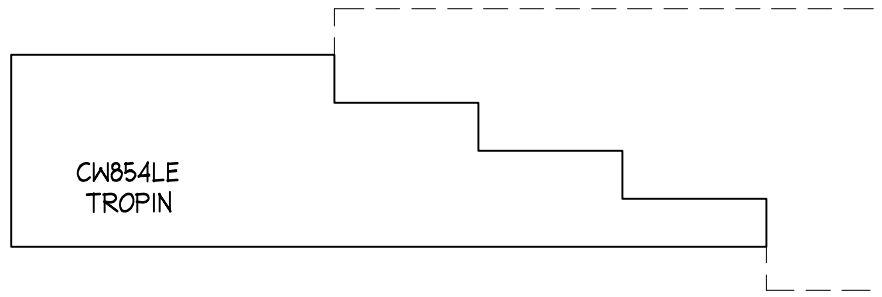
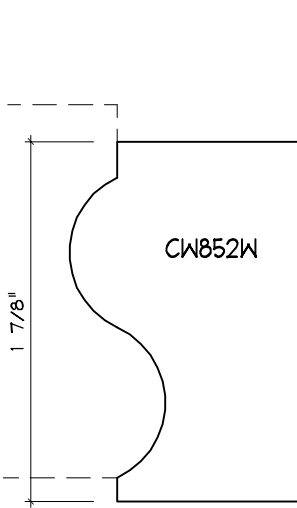
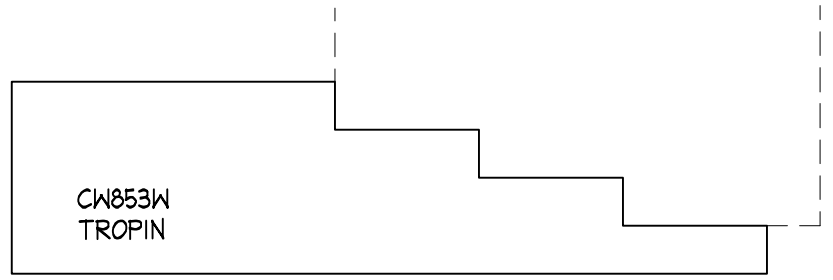
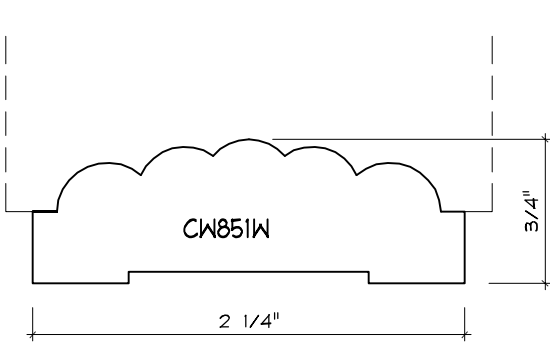

MISCELLANEOUS

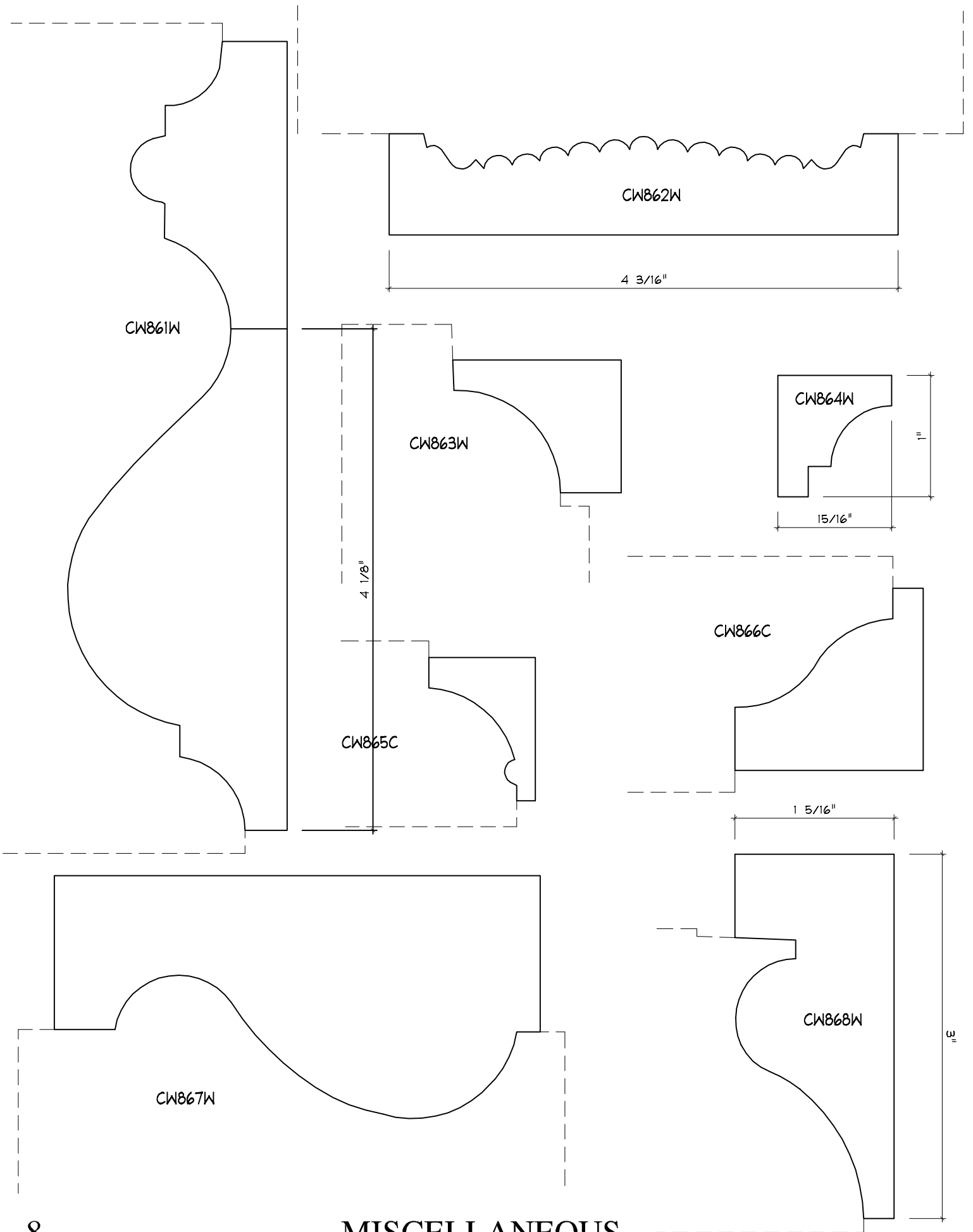

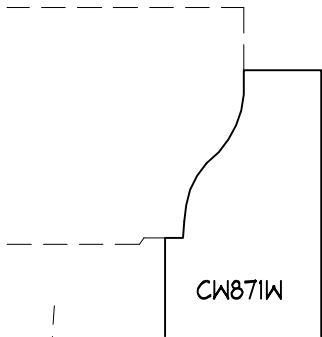
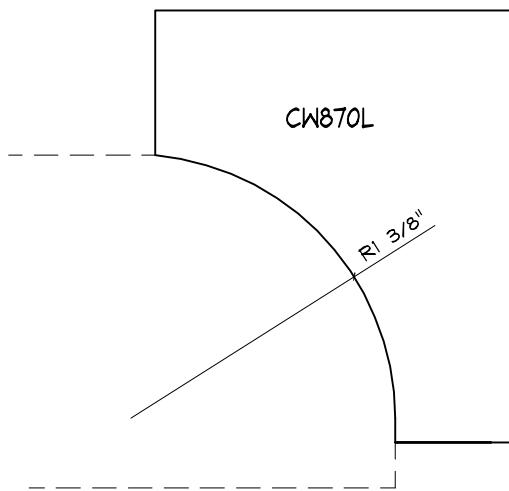
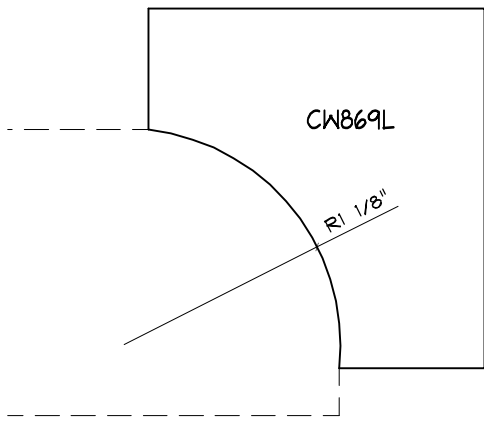

R = 9 5/16"

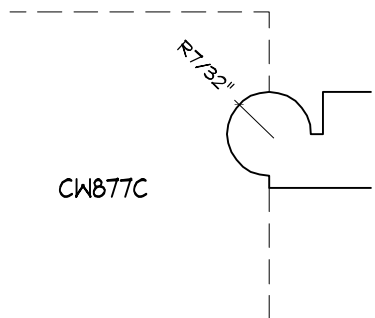
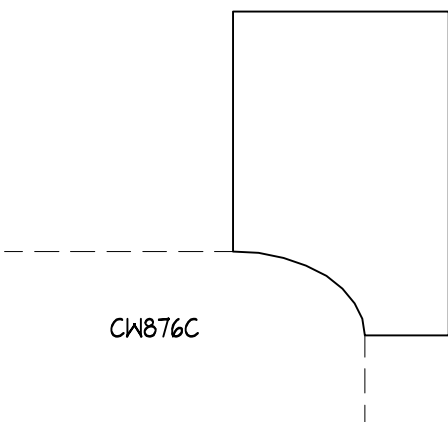
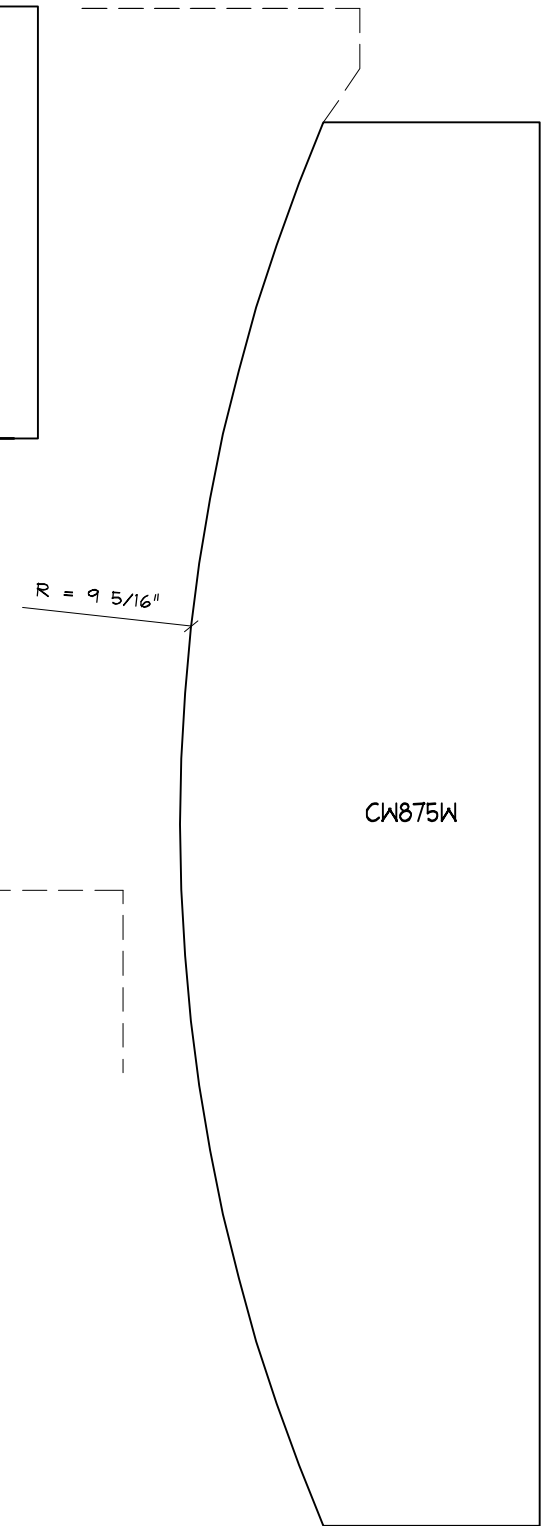
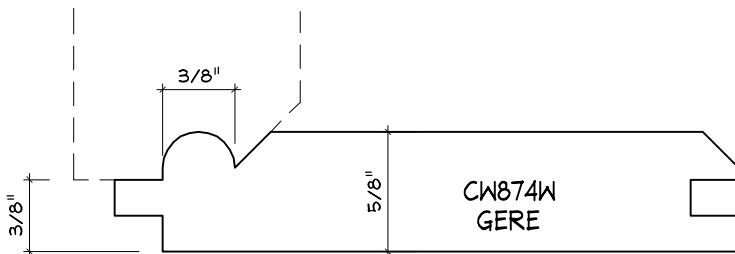
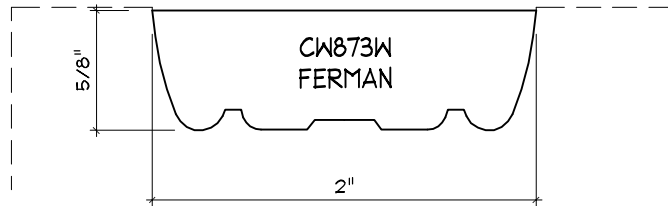
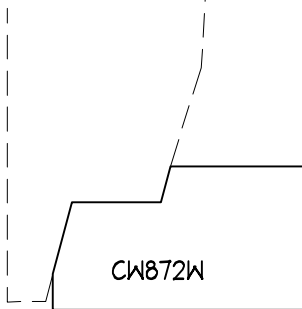

MISCELLANEOUS

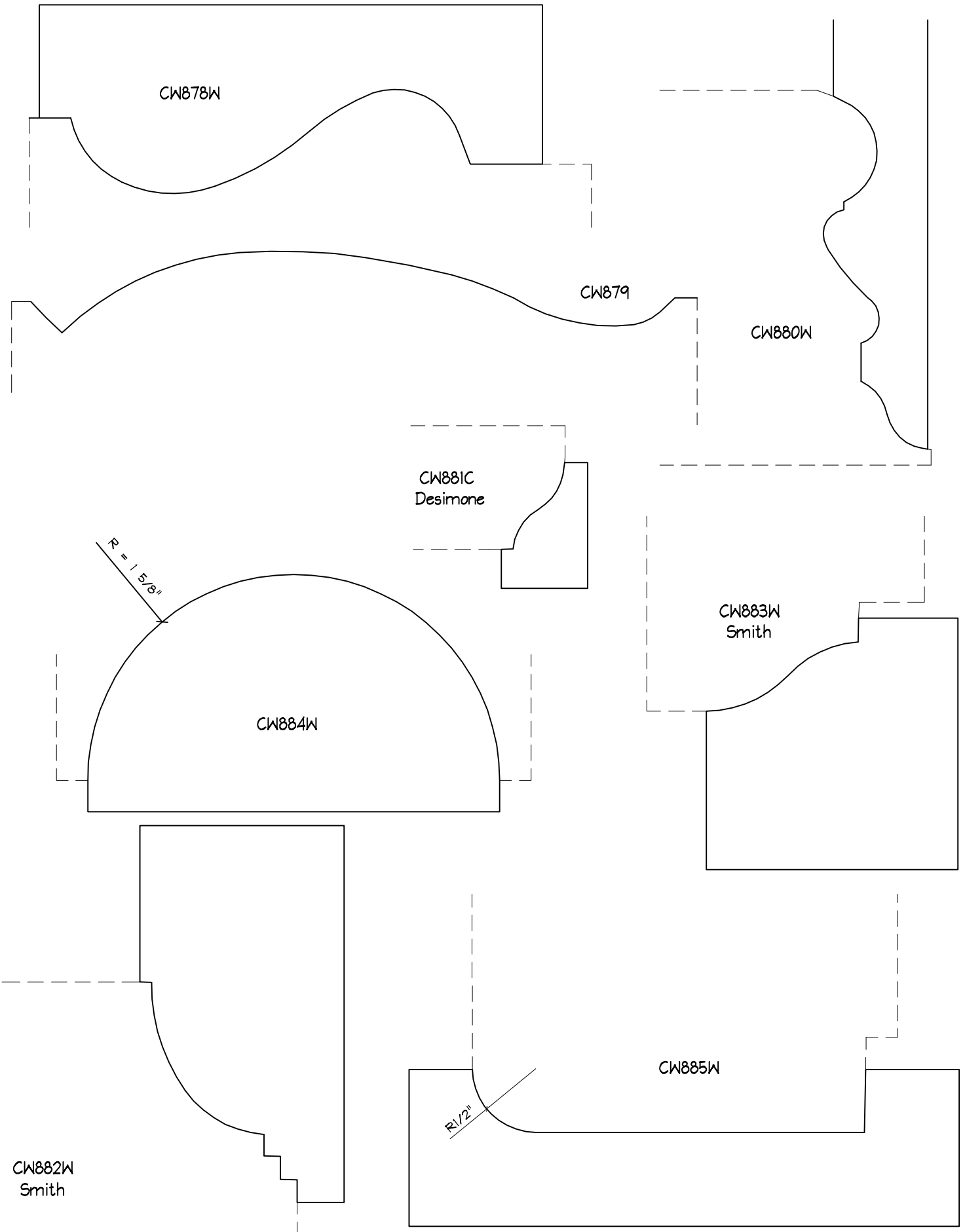

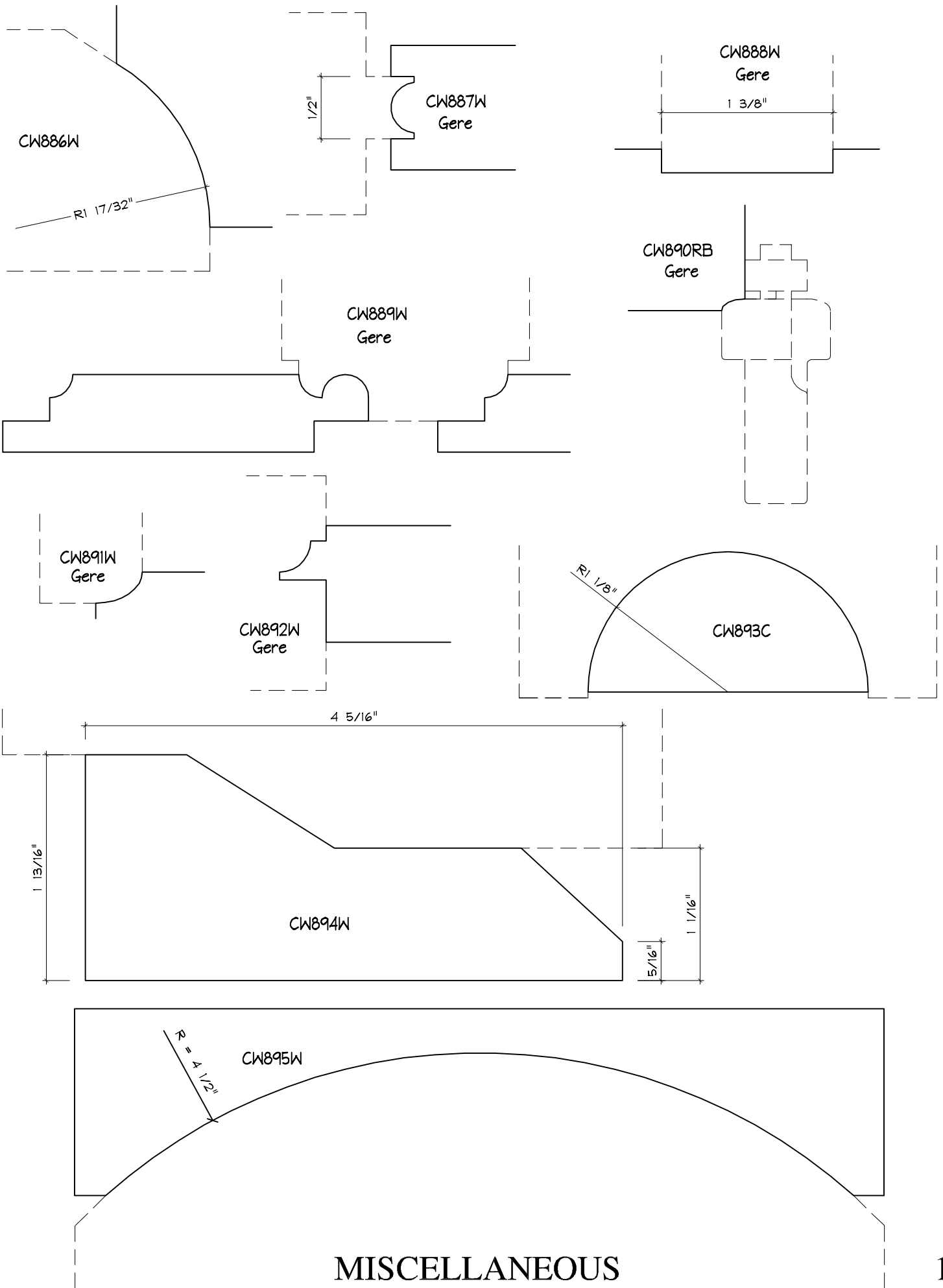

MISCELLANEOUS

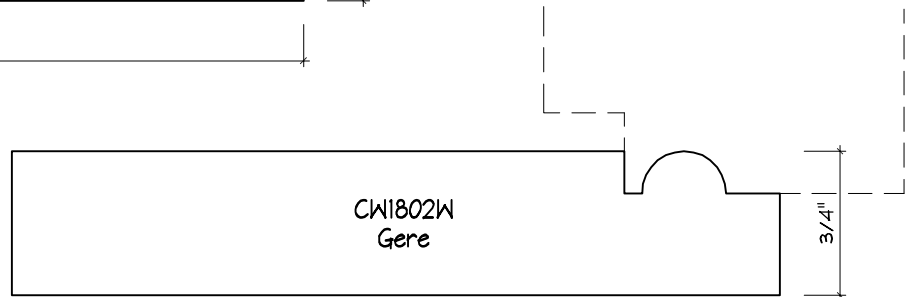
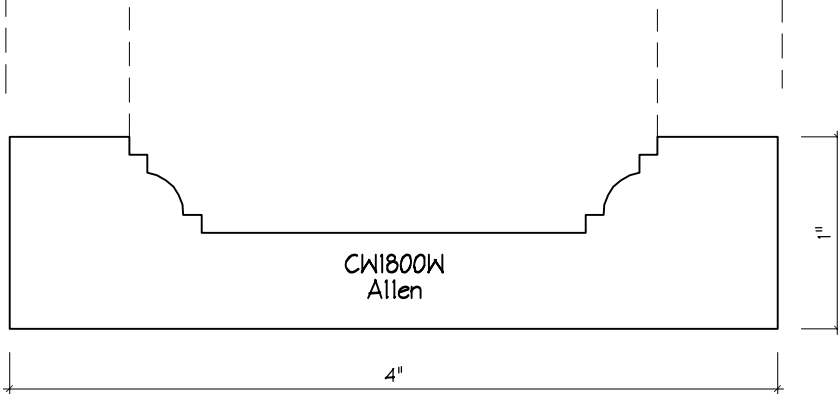
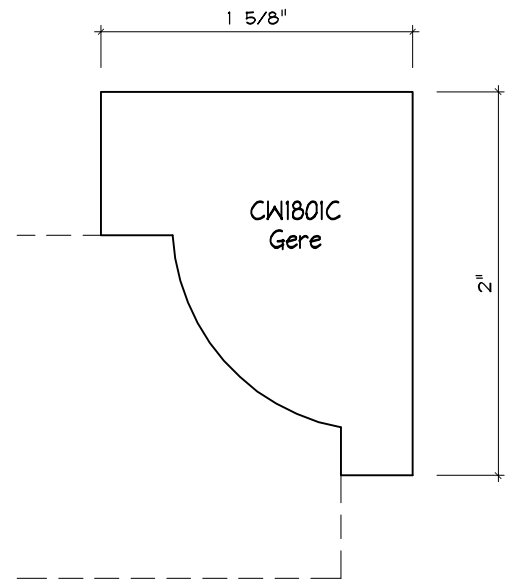
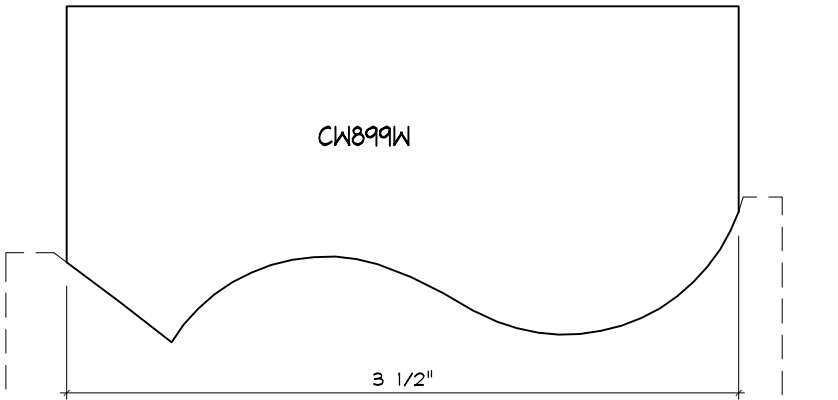
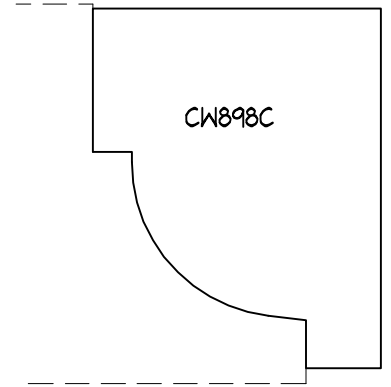
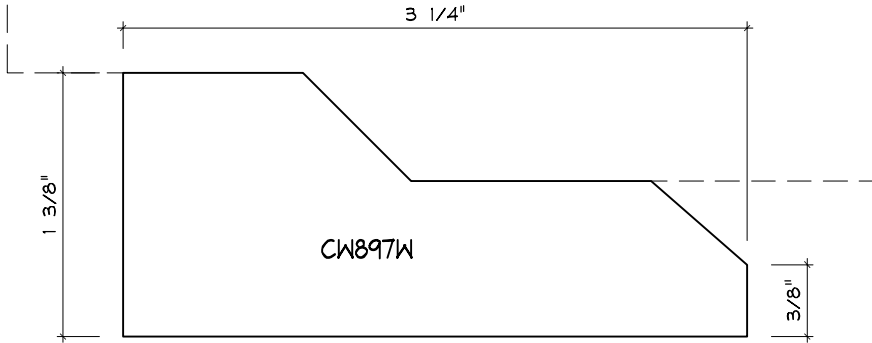
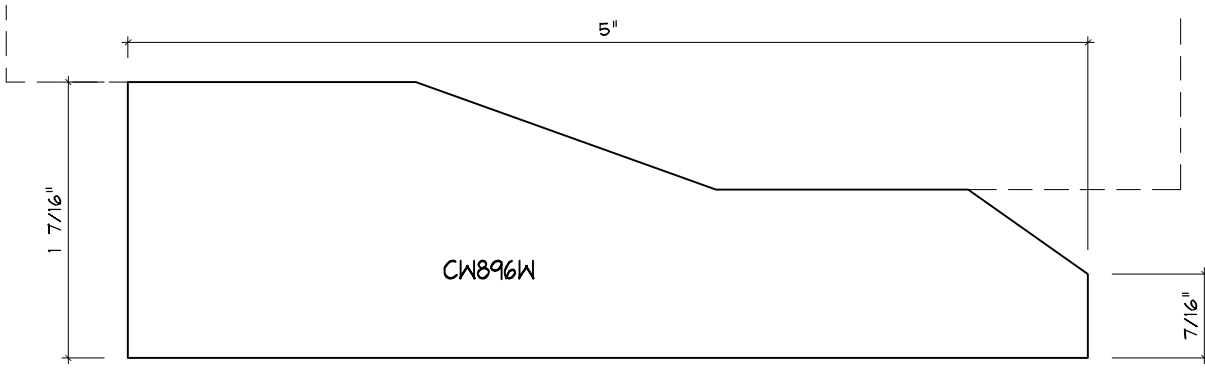

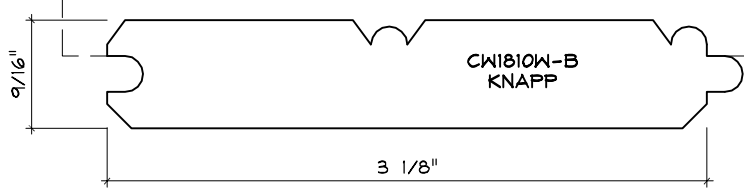
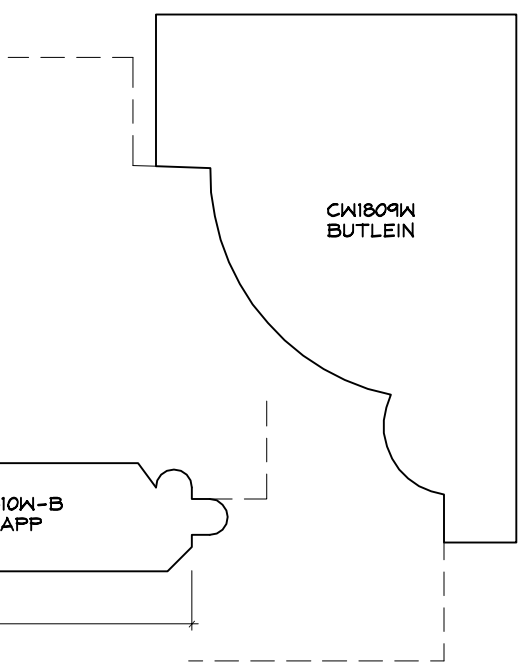
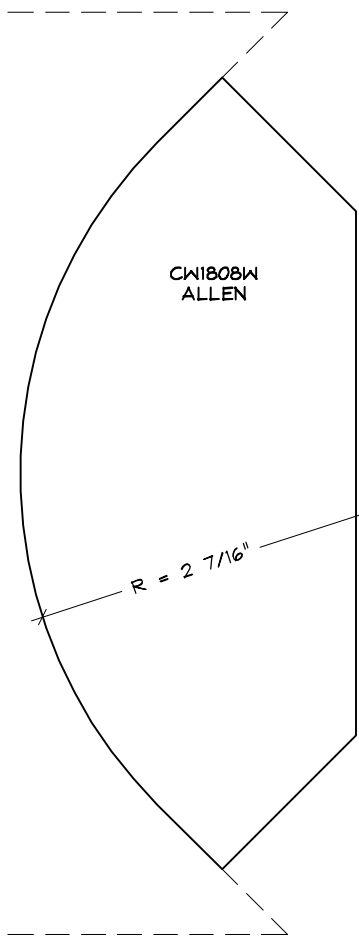
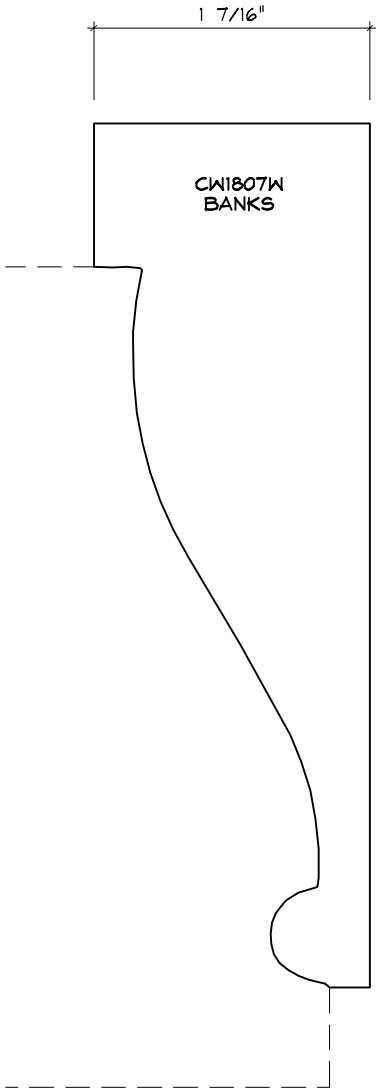
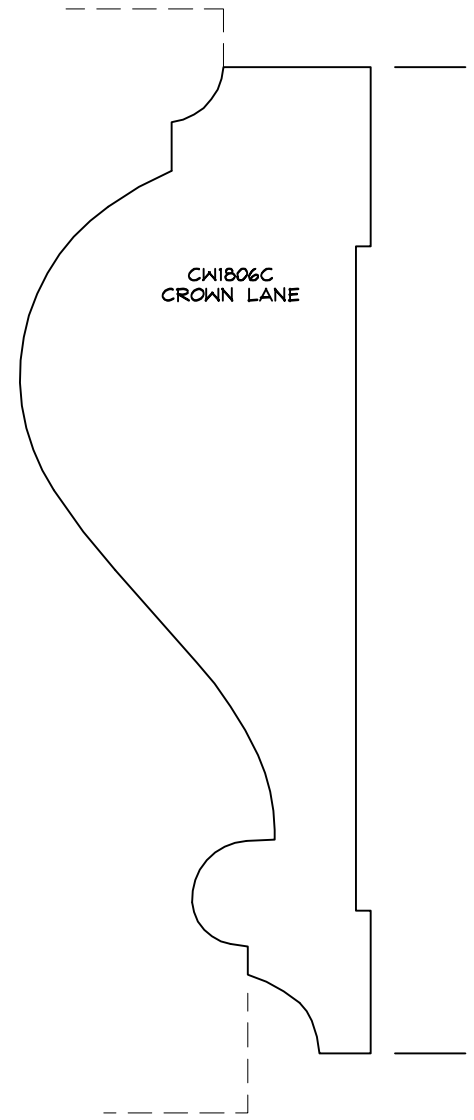
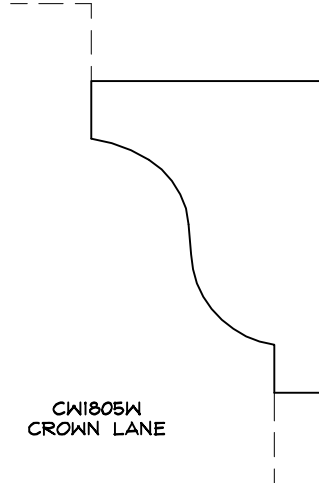
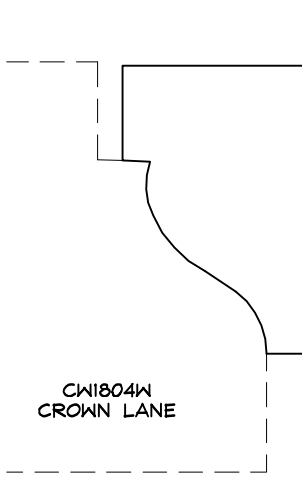
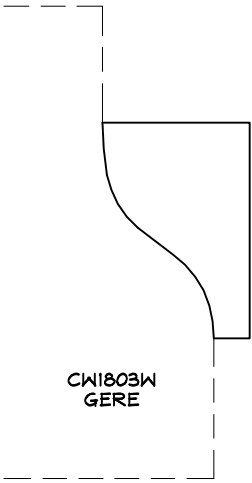

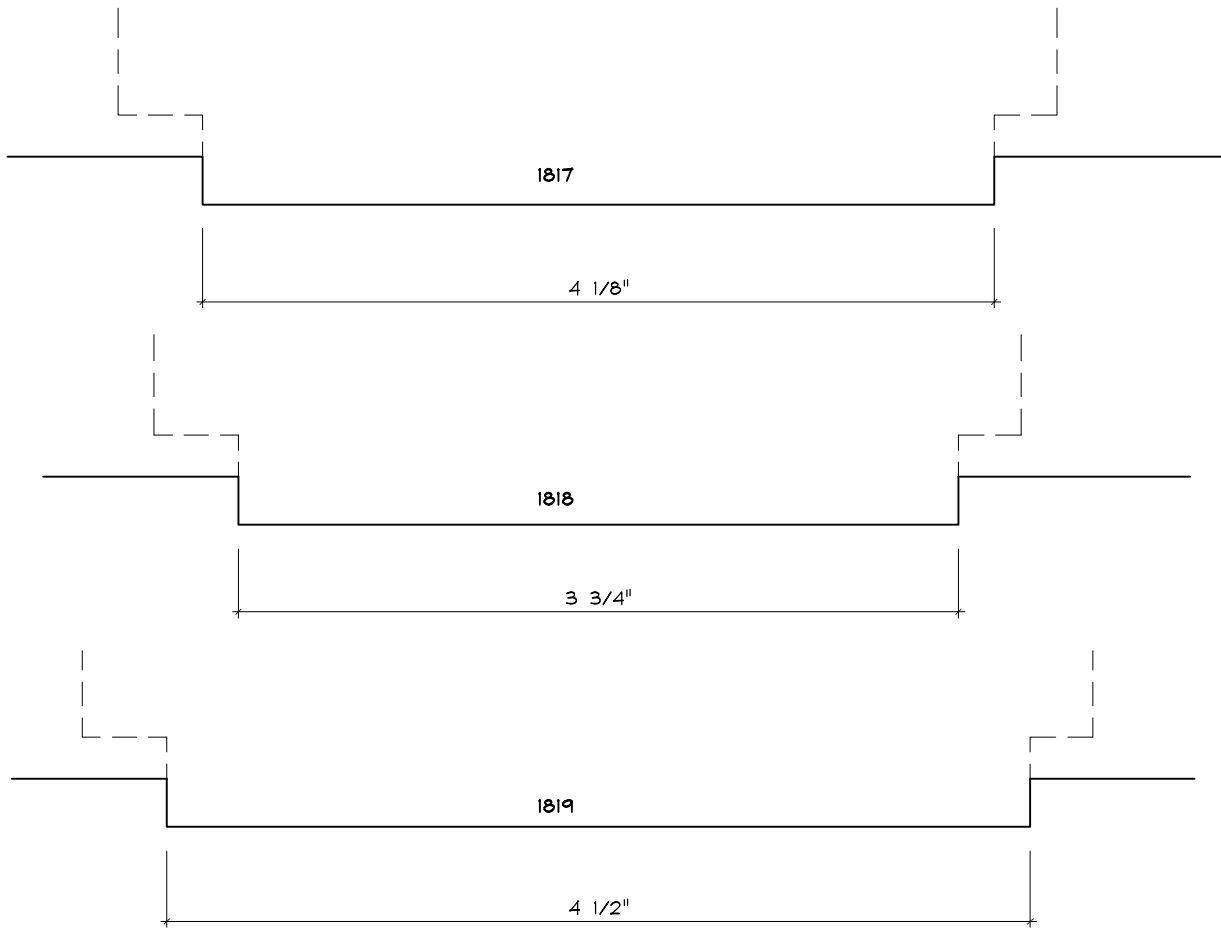
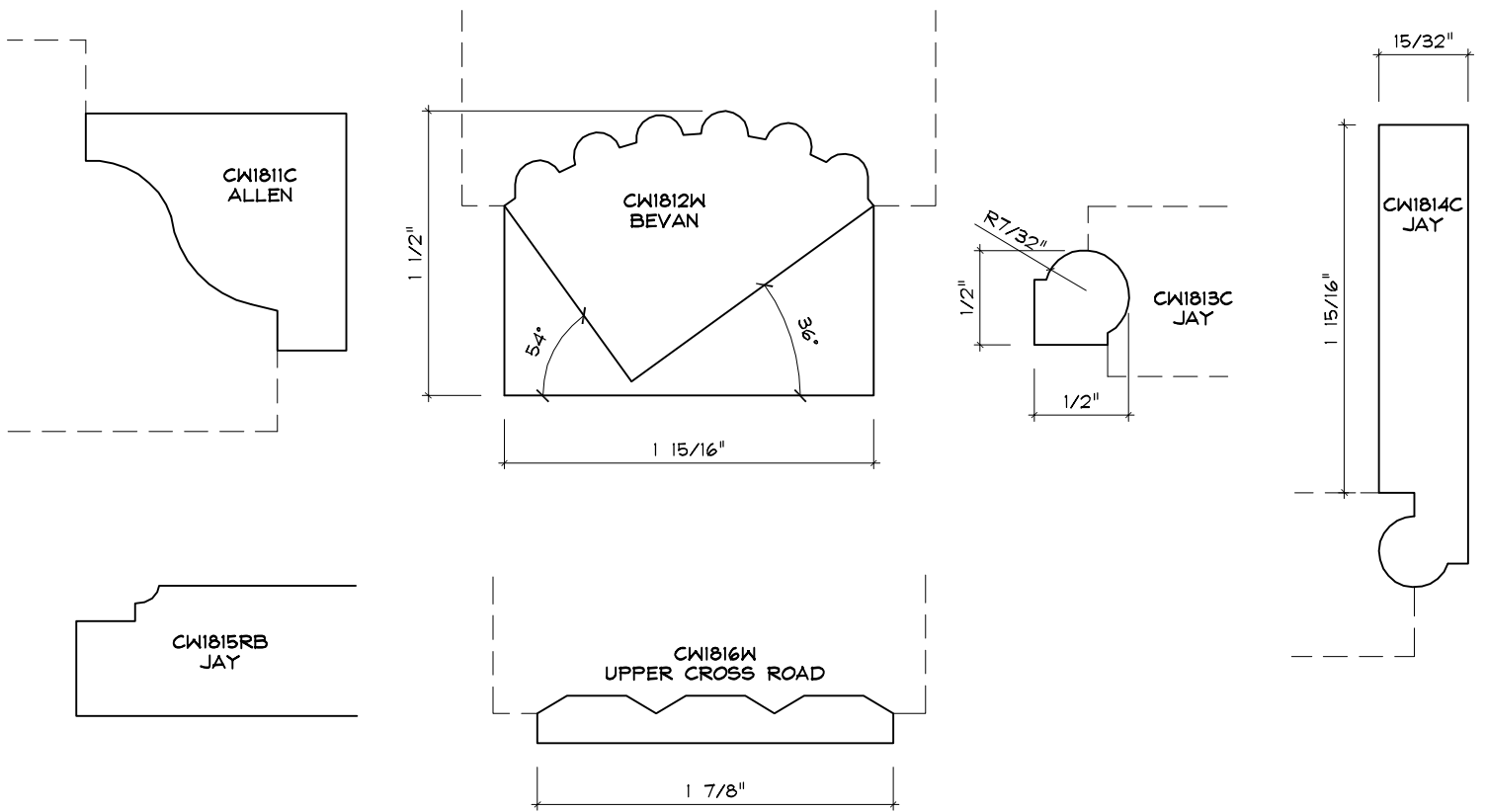

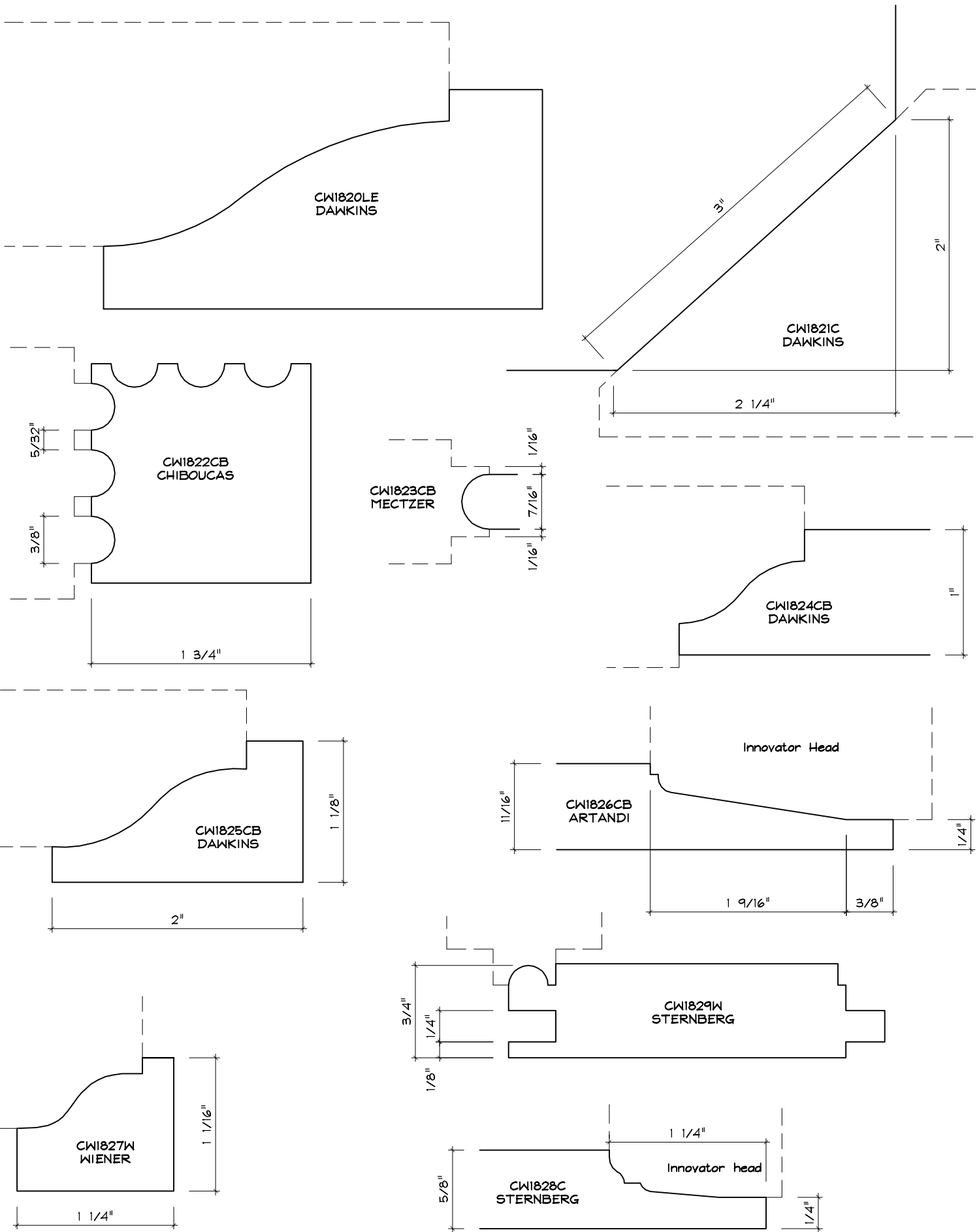

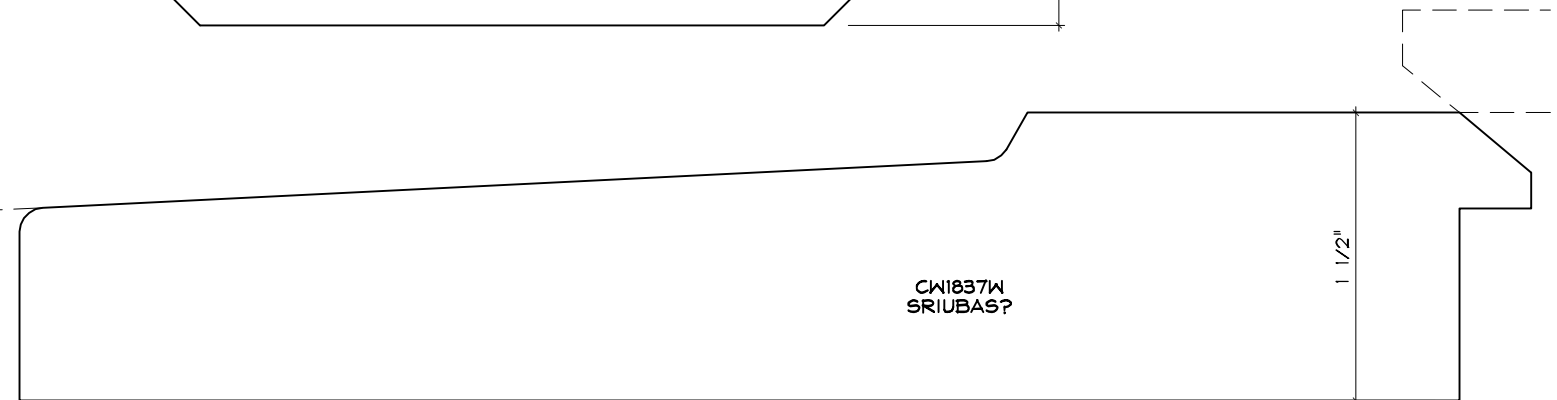
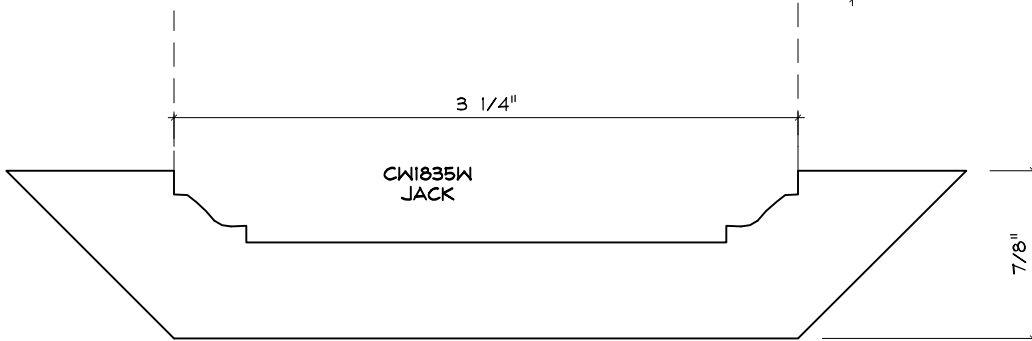
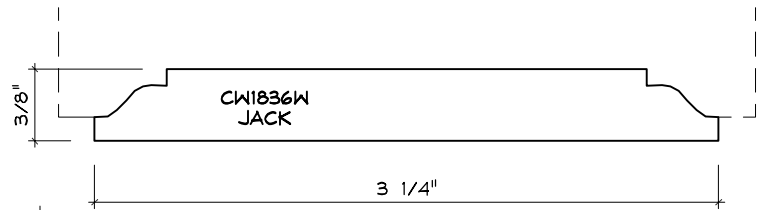
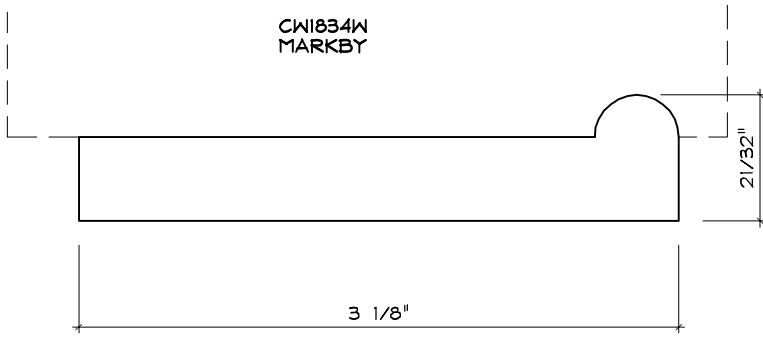
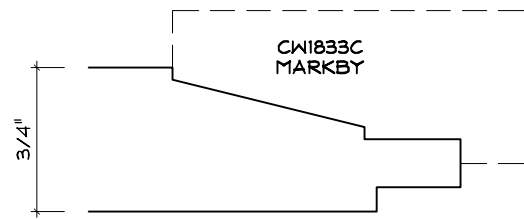
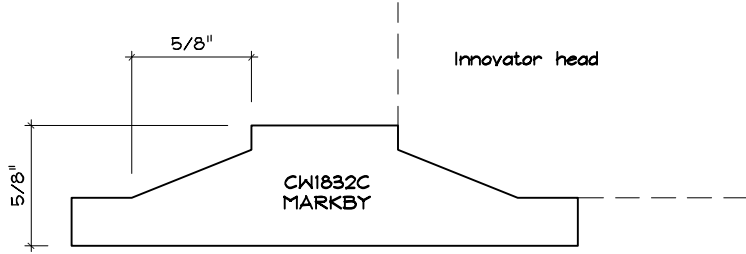
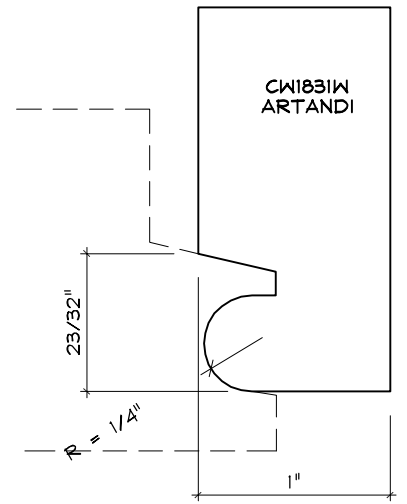
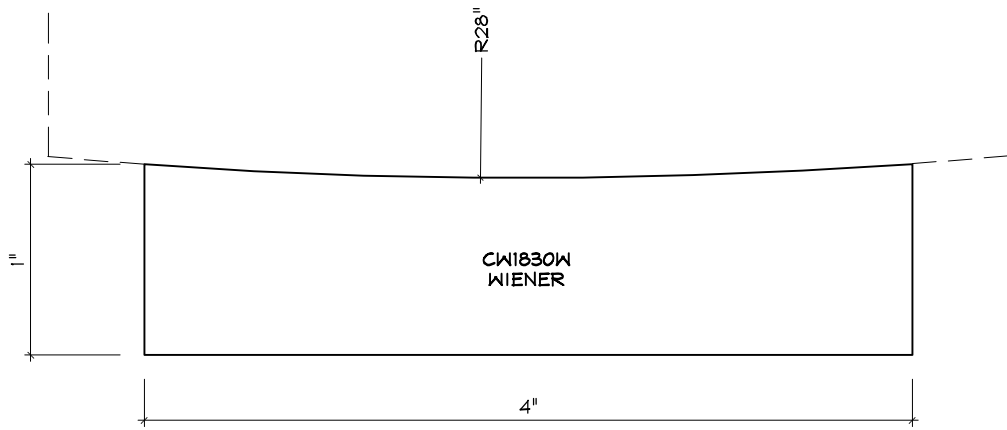

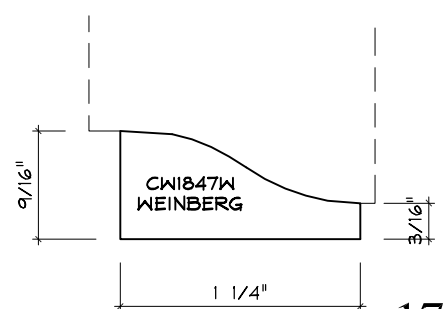
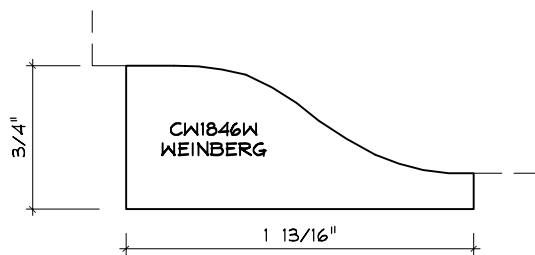
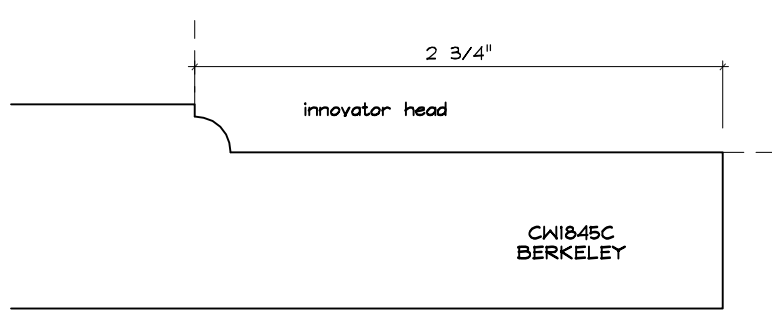
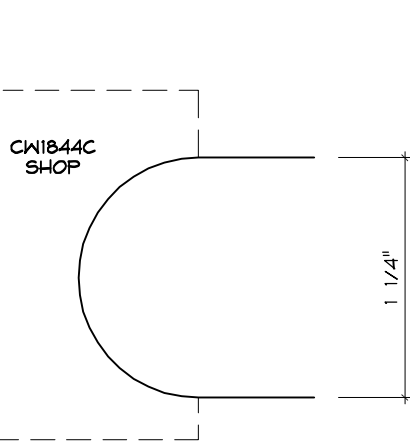
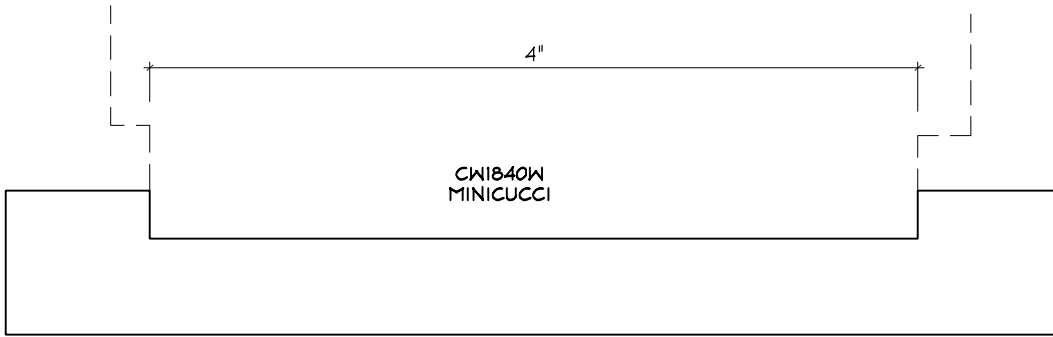
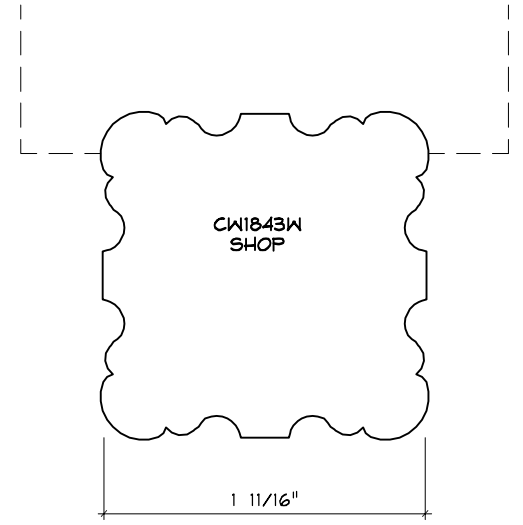
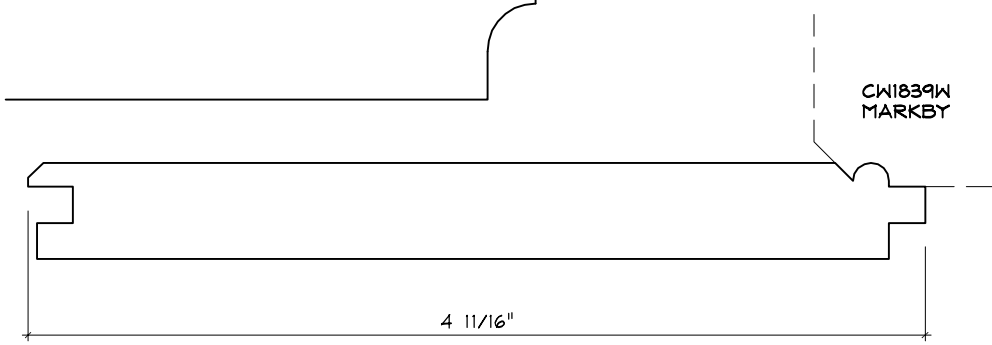
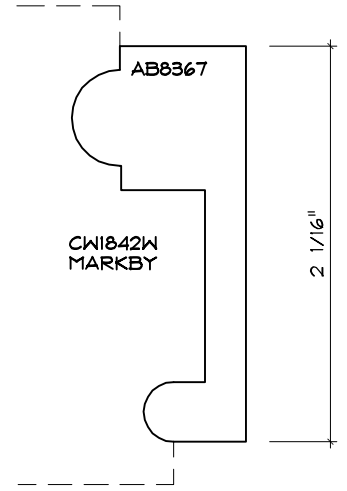
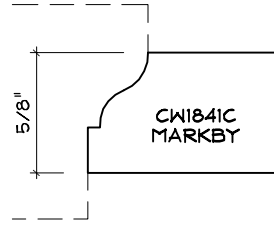
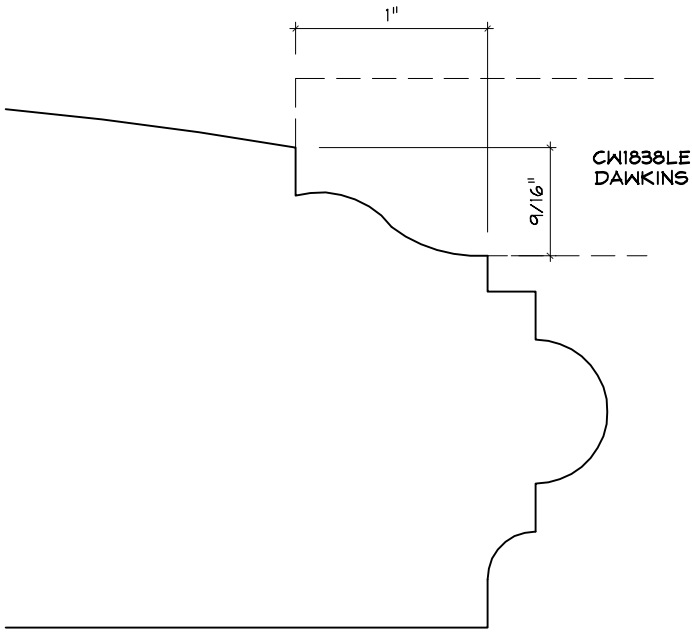

MISCELLANEOUS

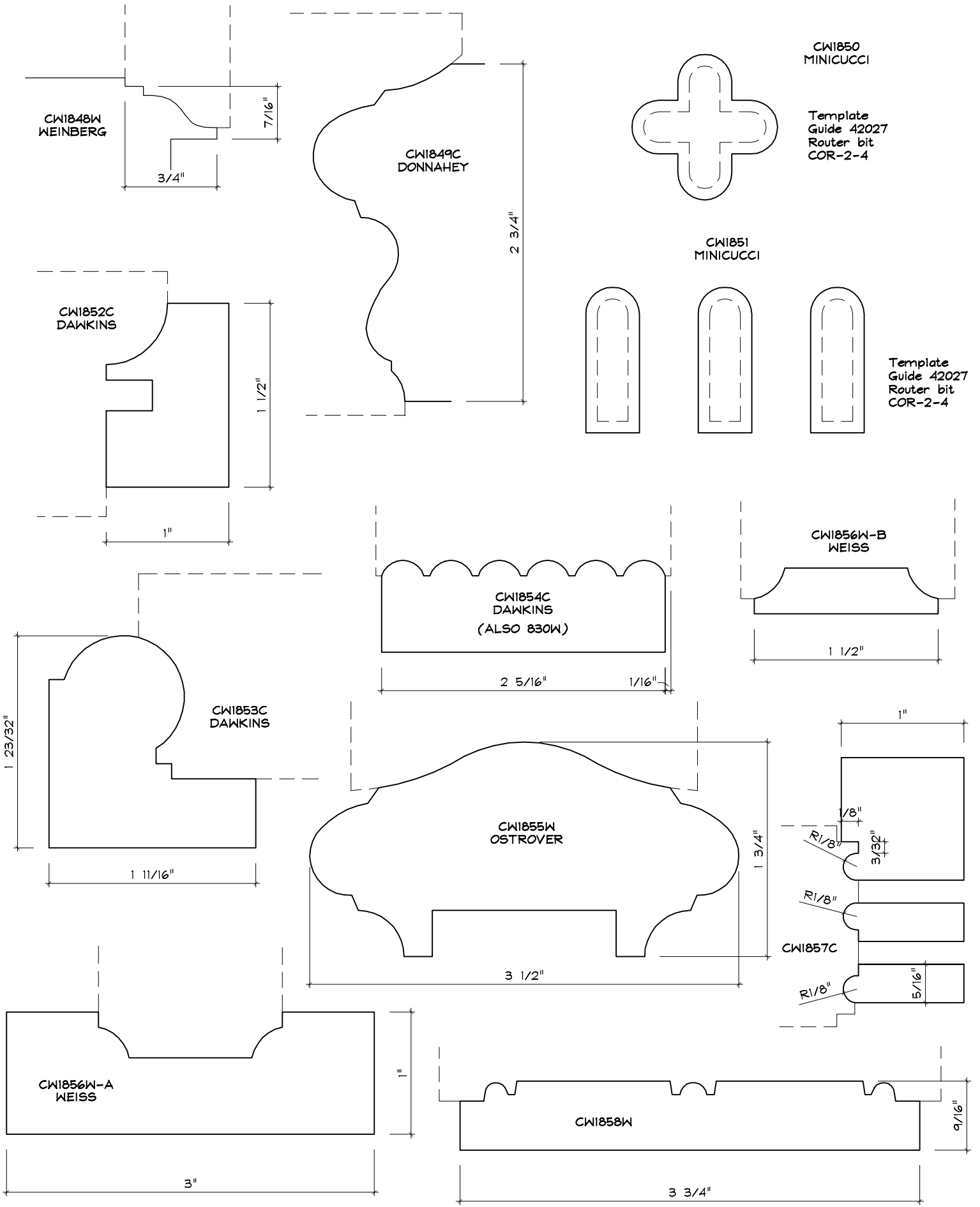

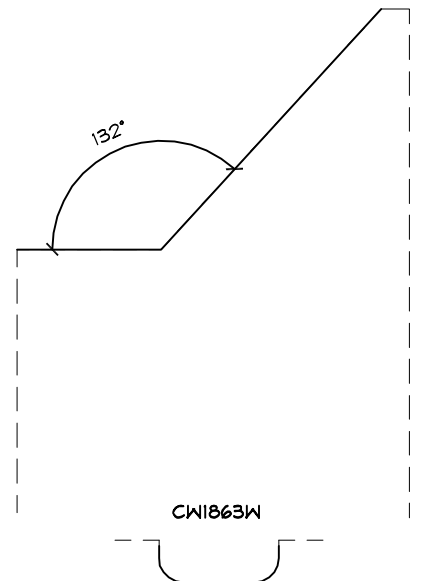
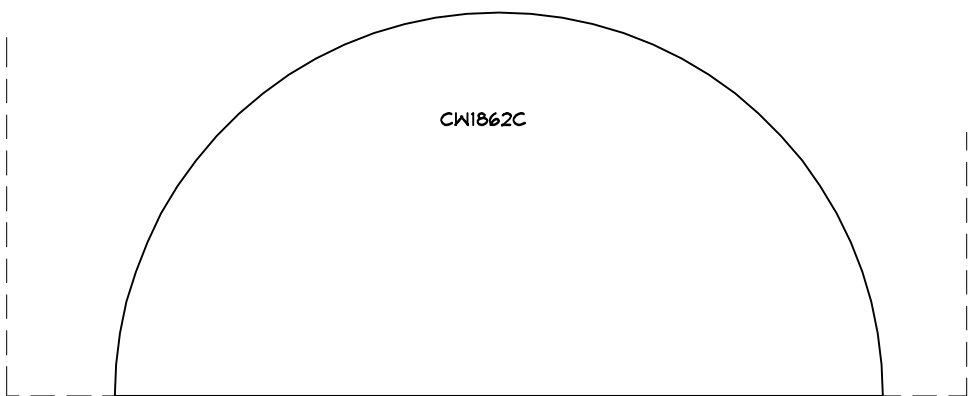
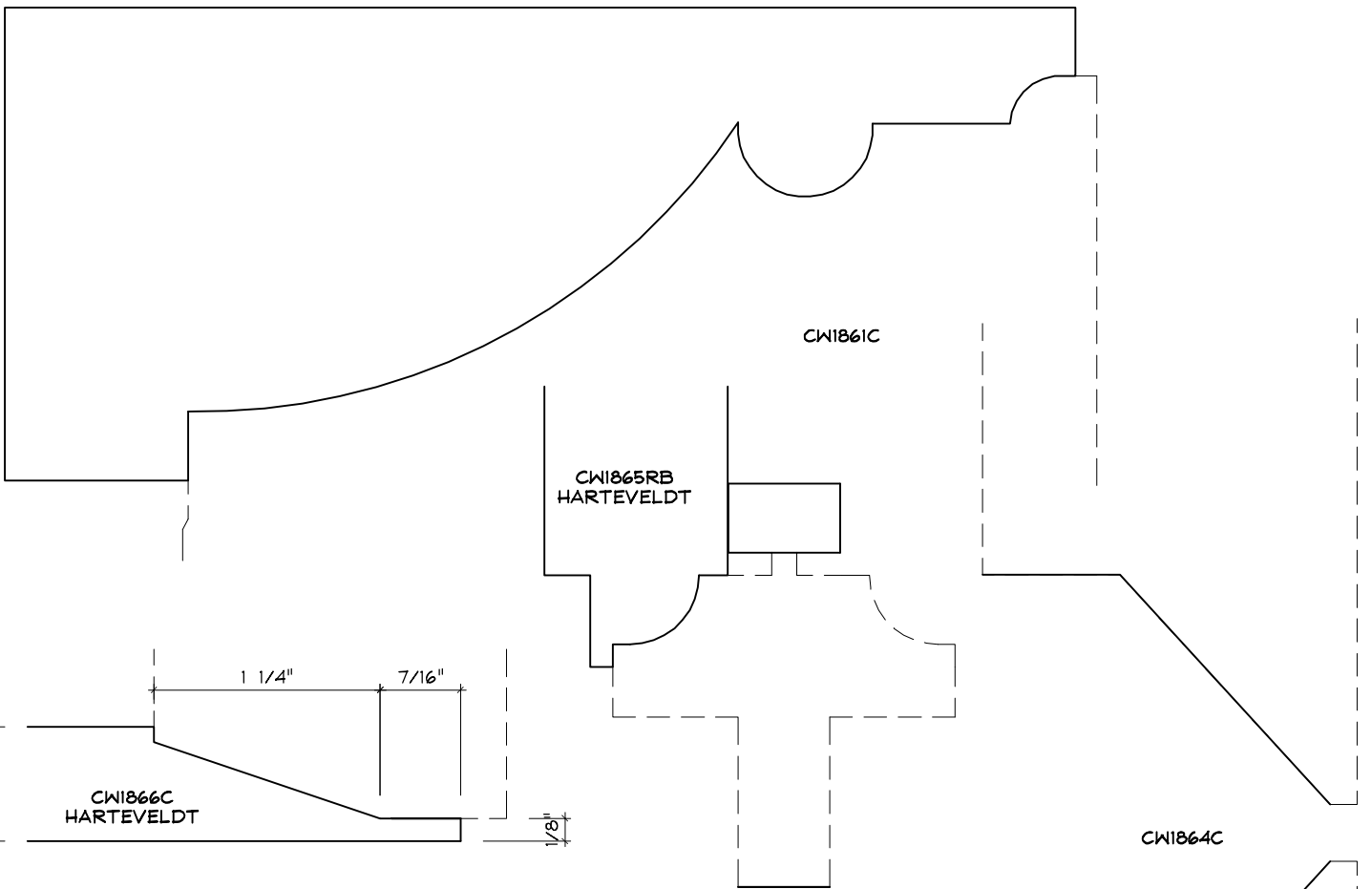
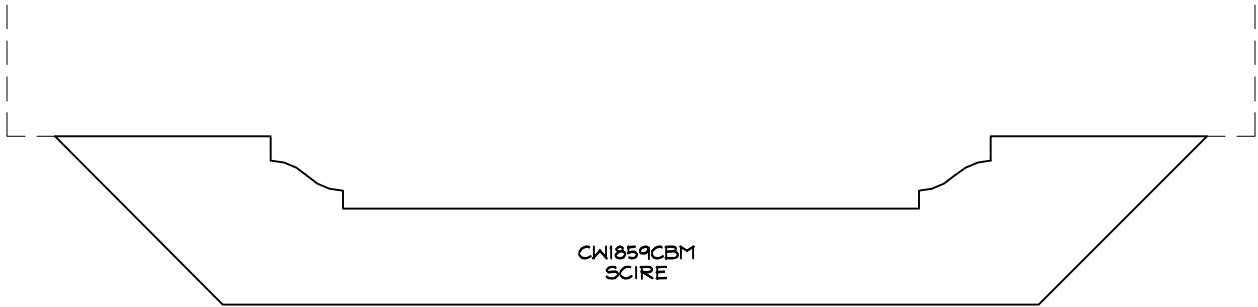

MISCELLANEOUS

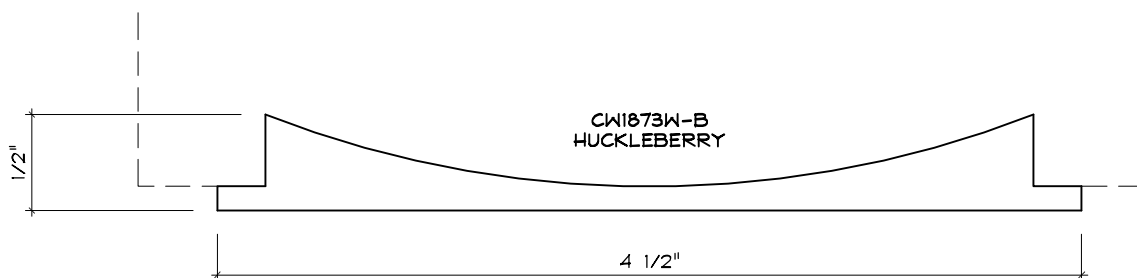
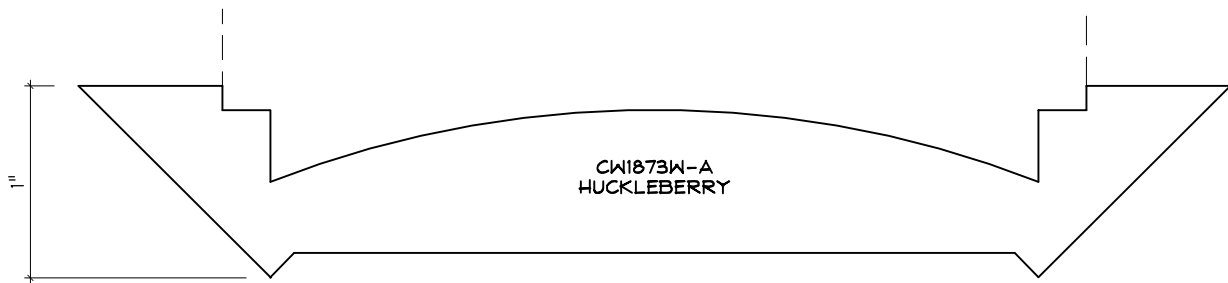
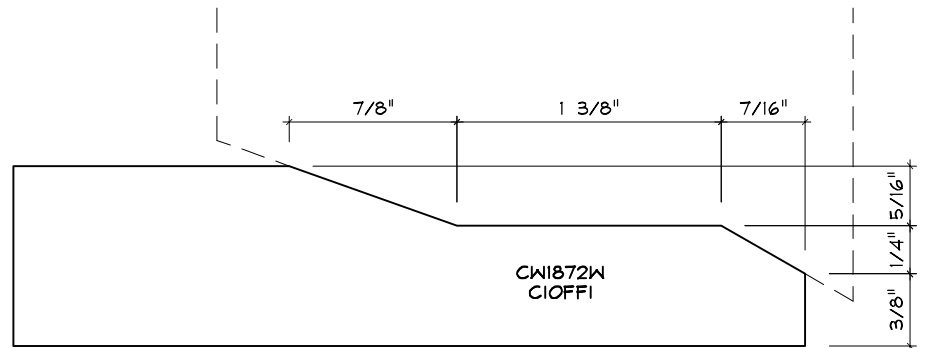
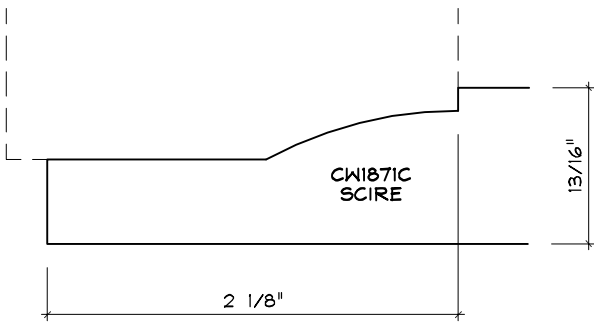
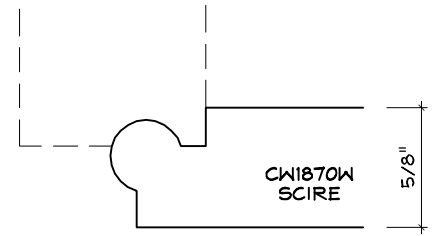
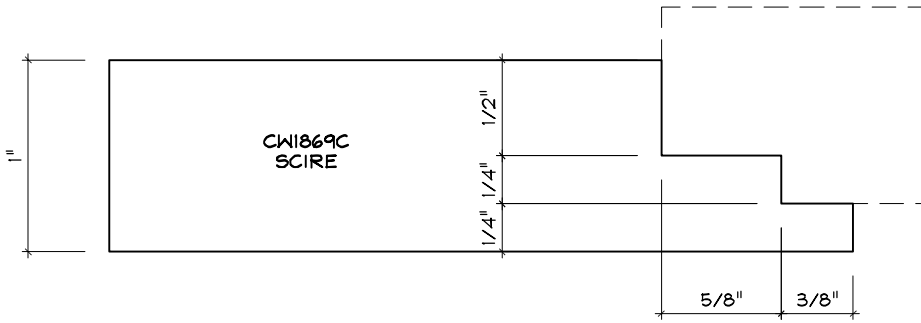
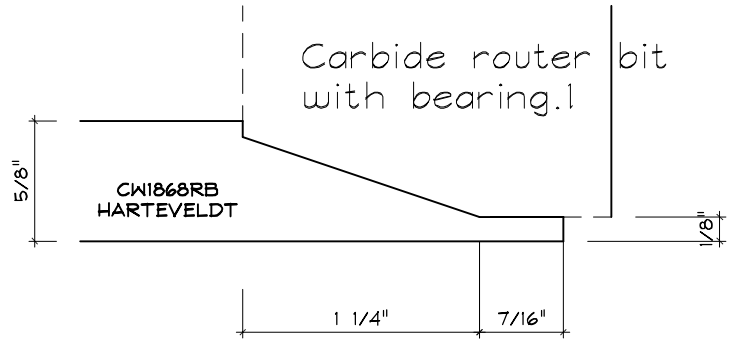
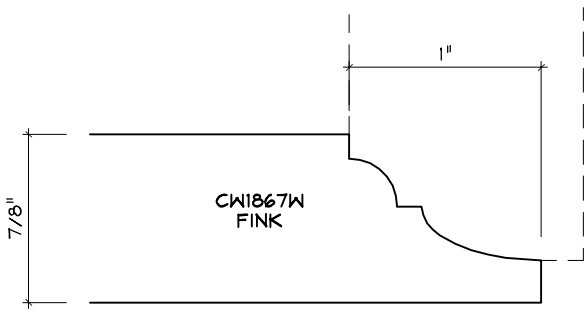

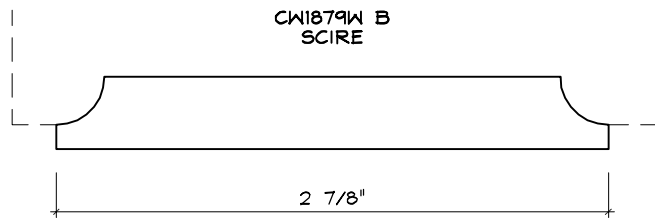
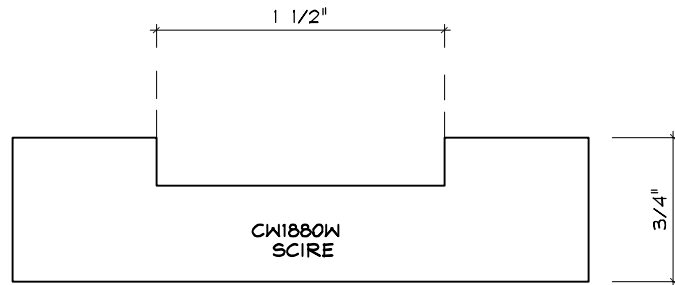
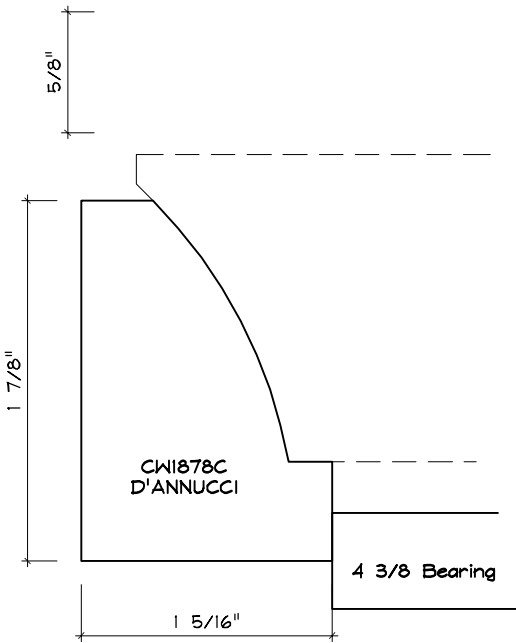
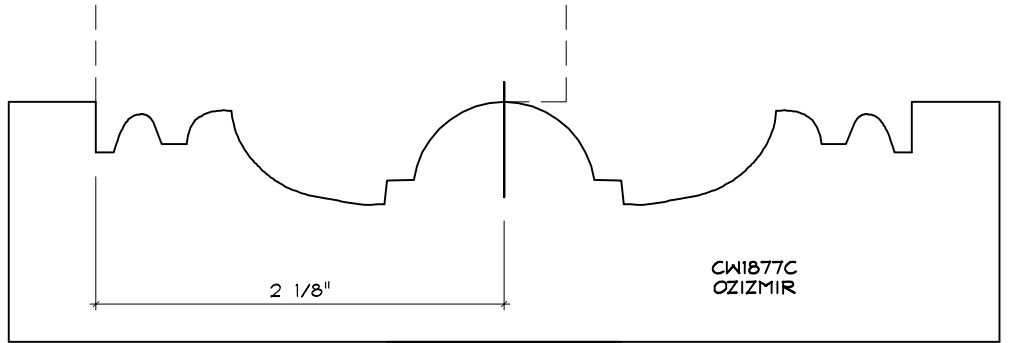
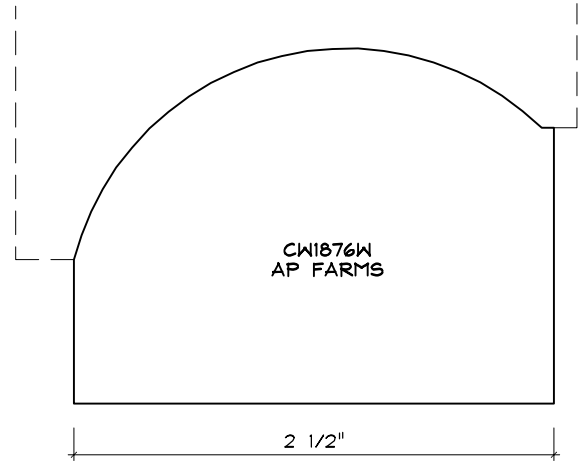
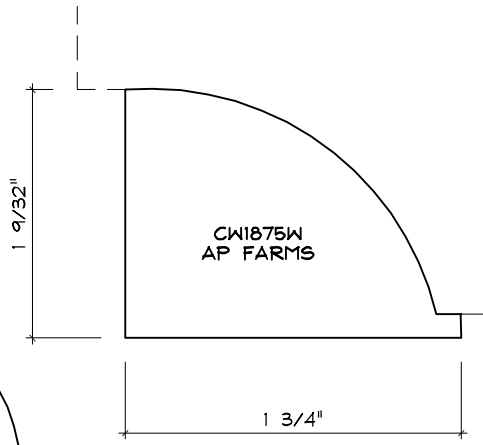
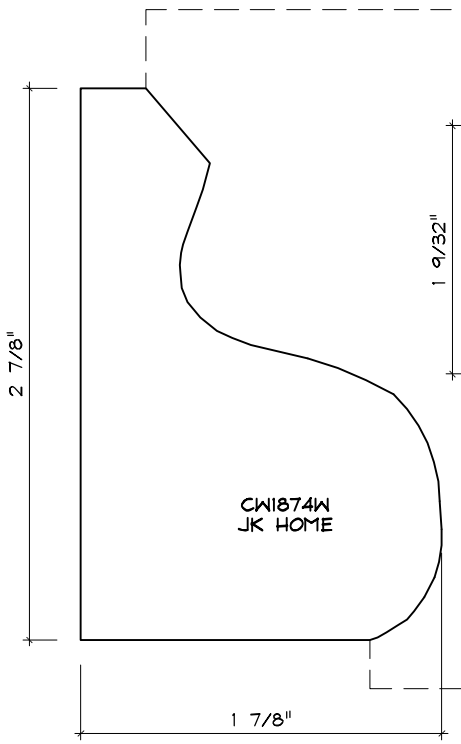

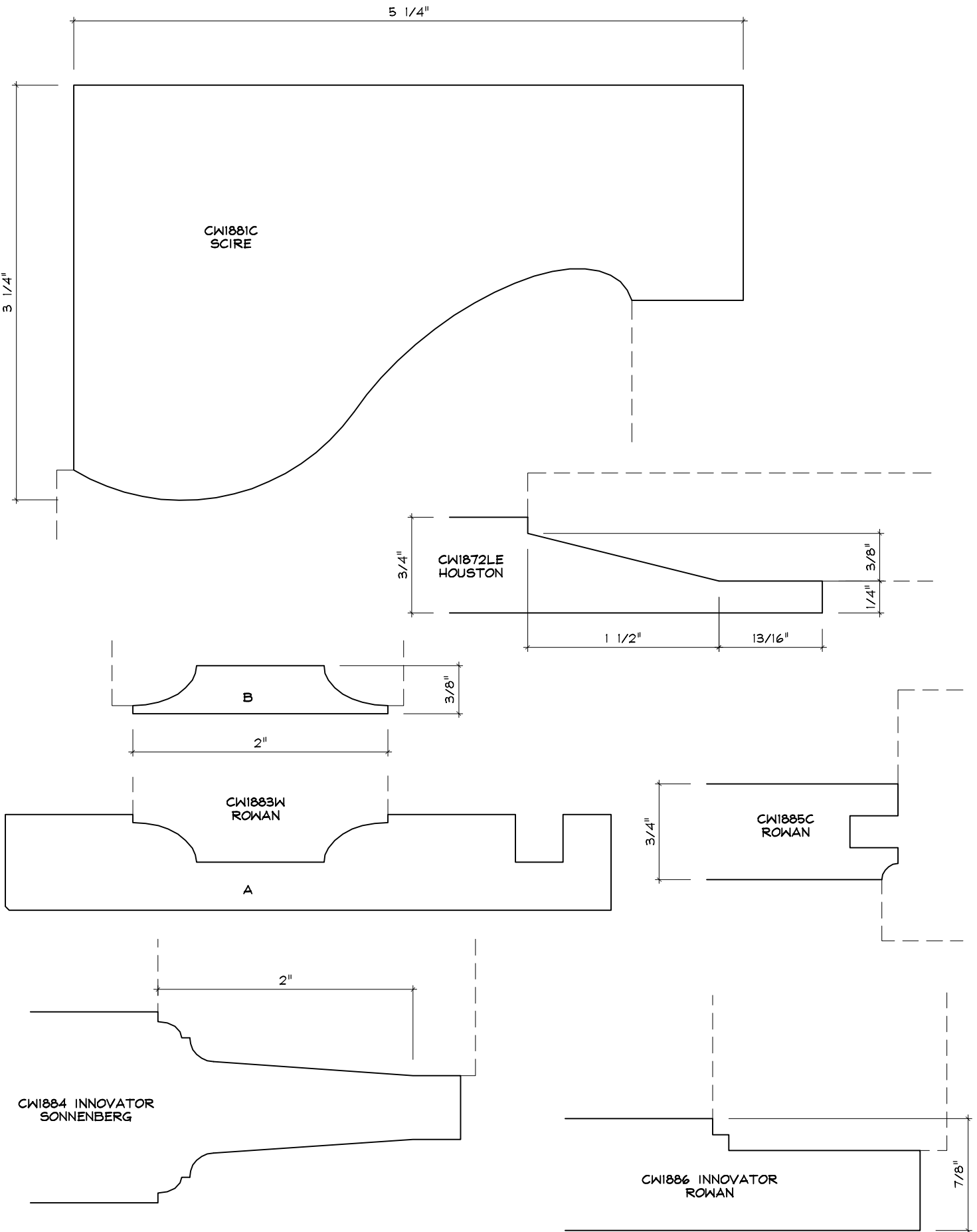

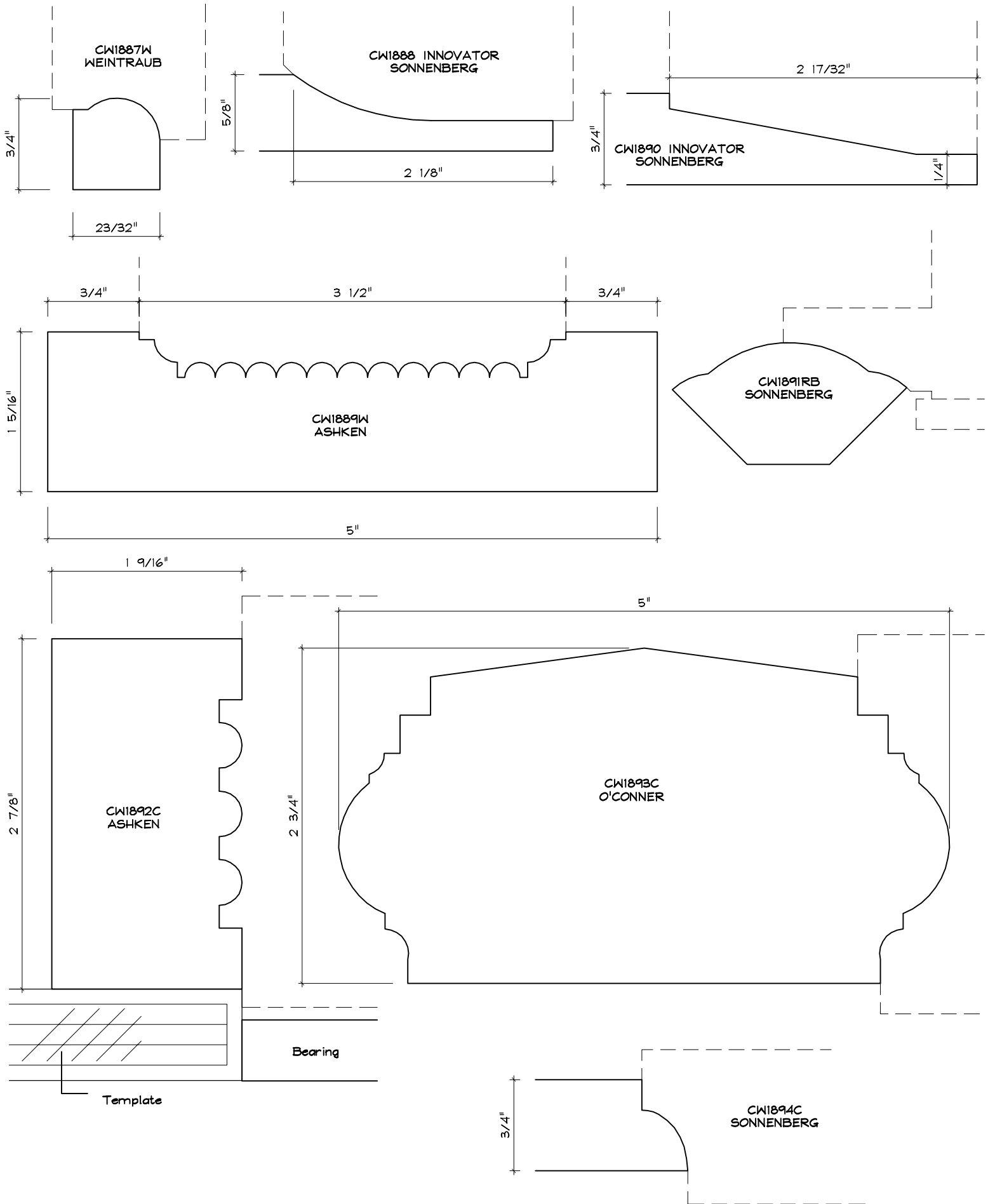

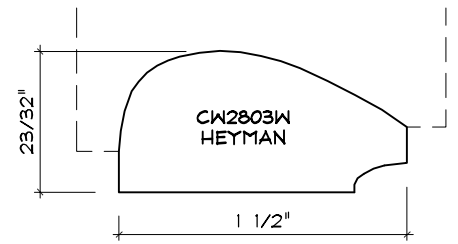
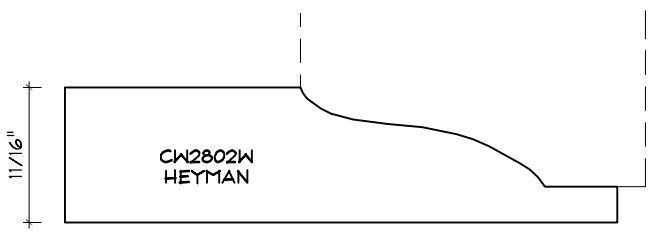
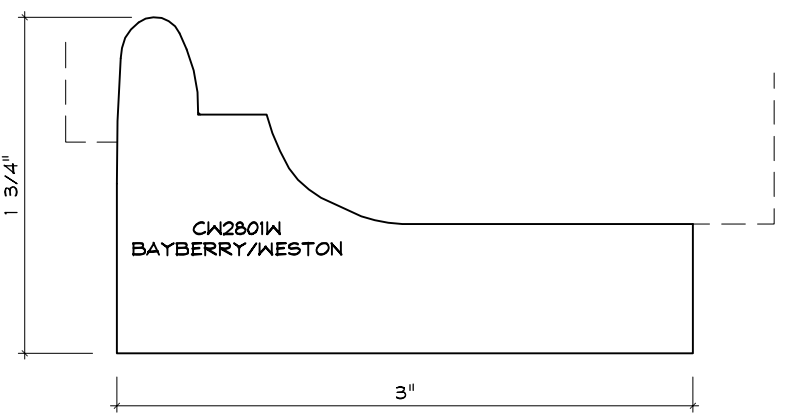
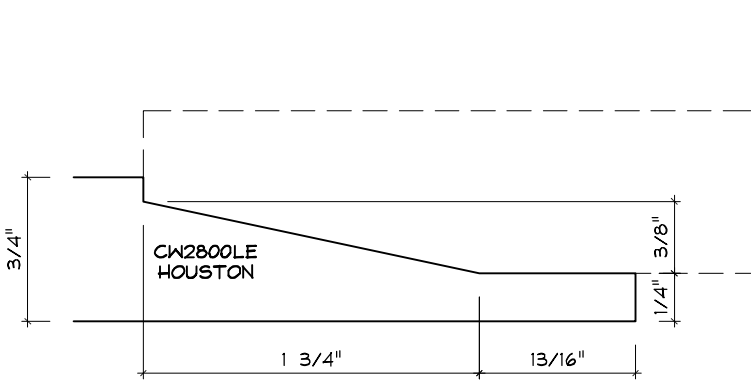
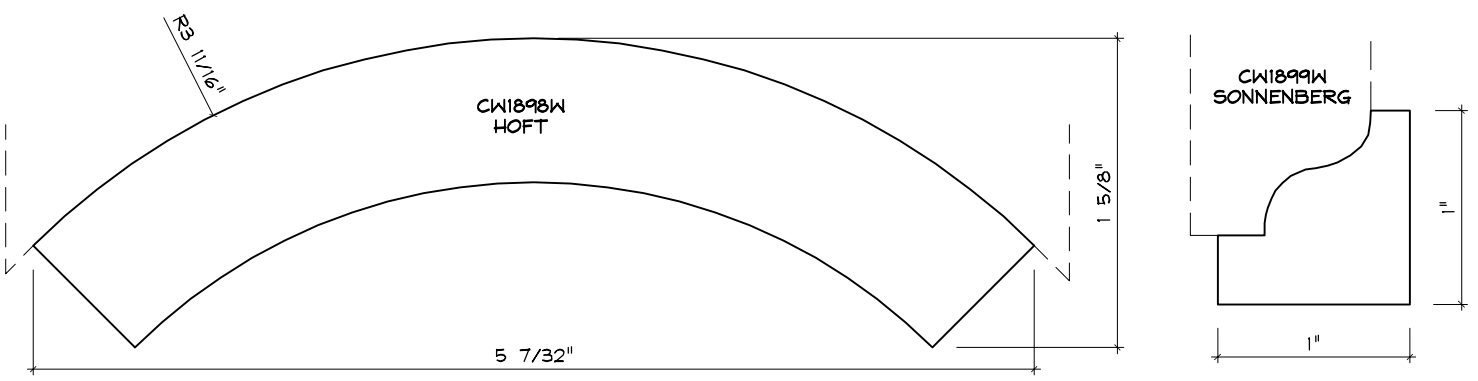
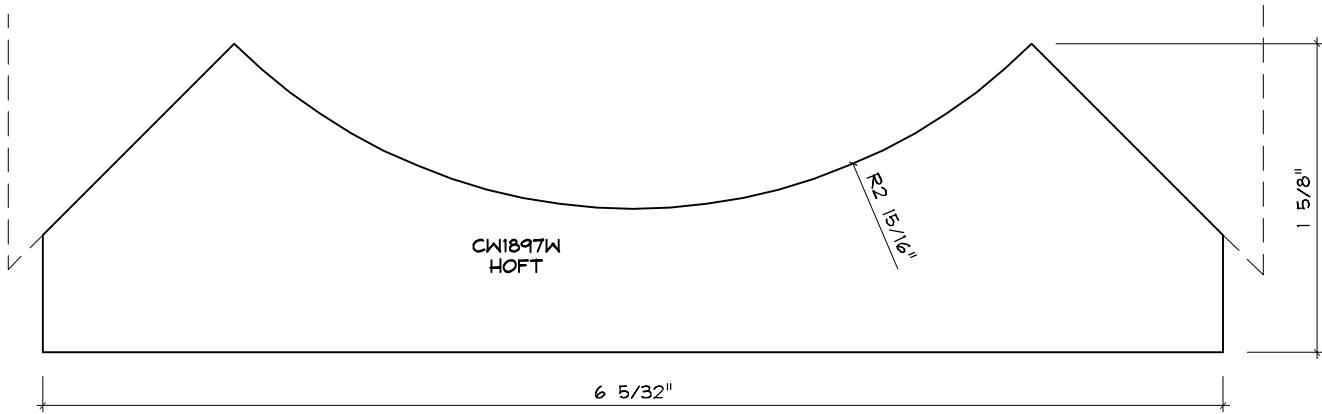
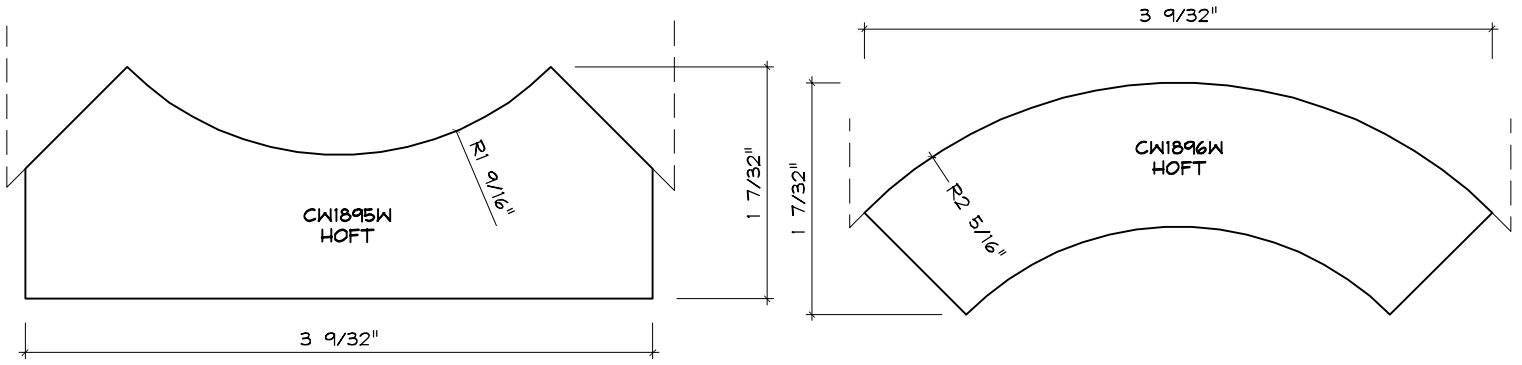

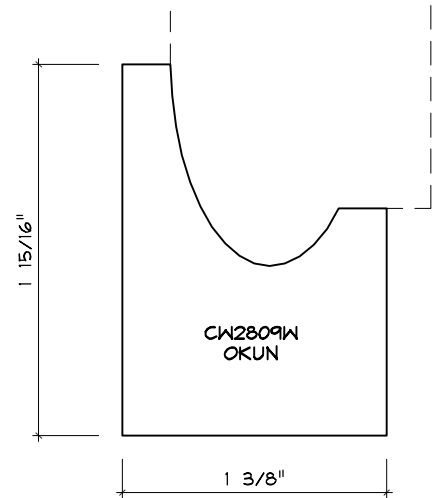
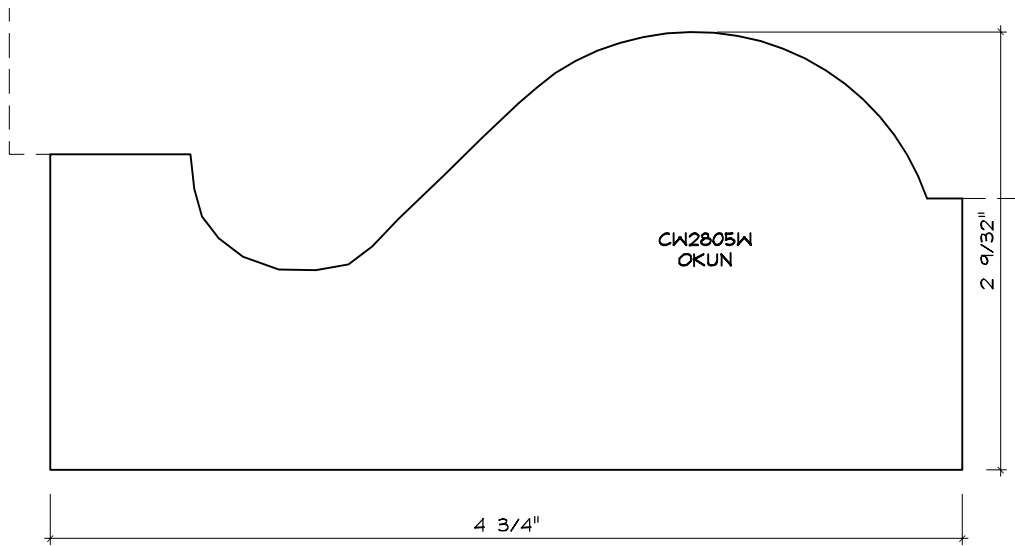
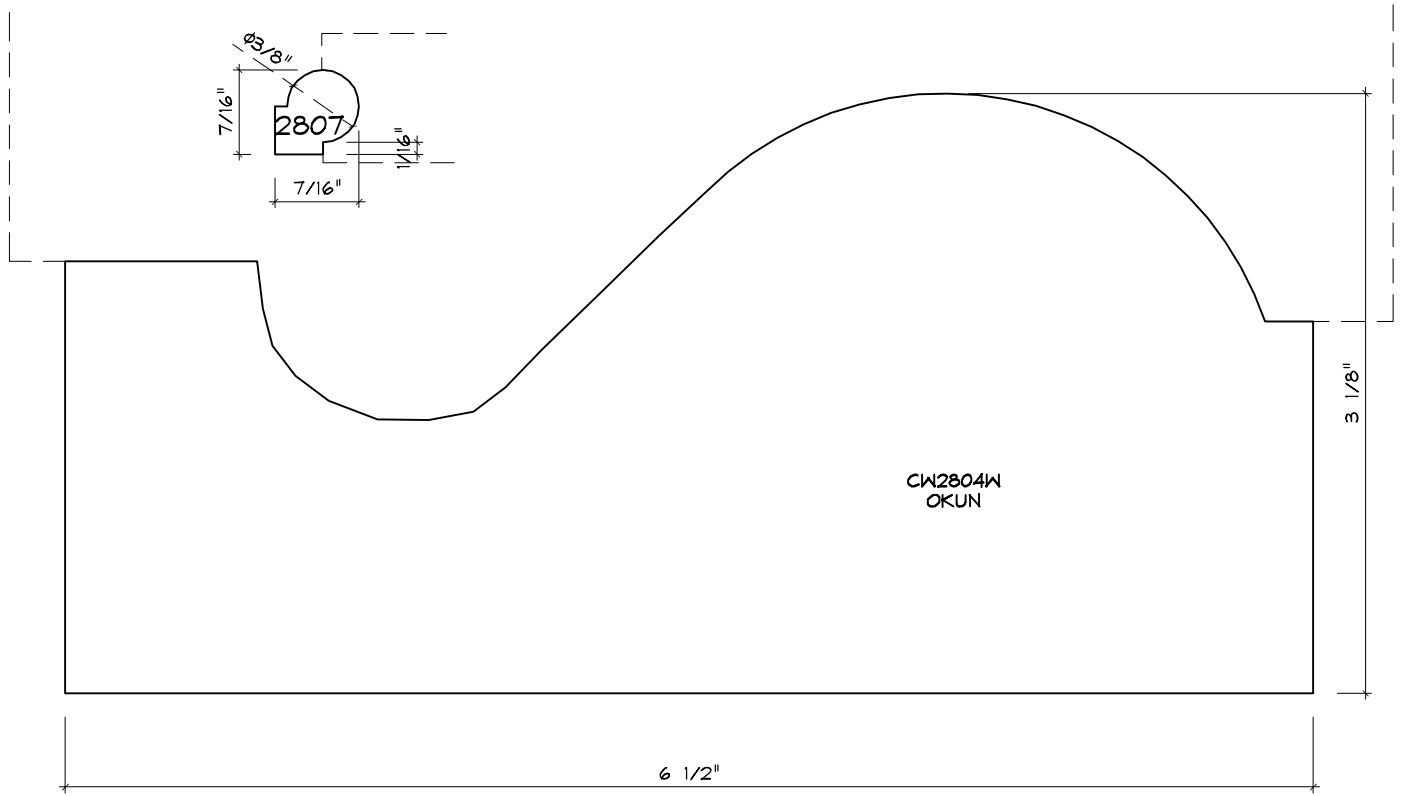

CW2807?

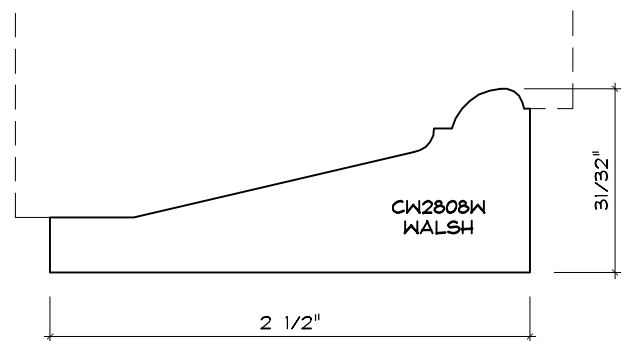
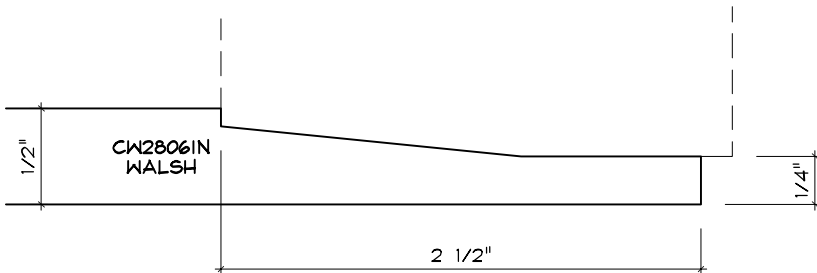

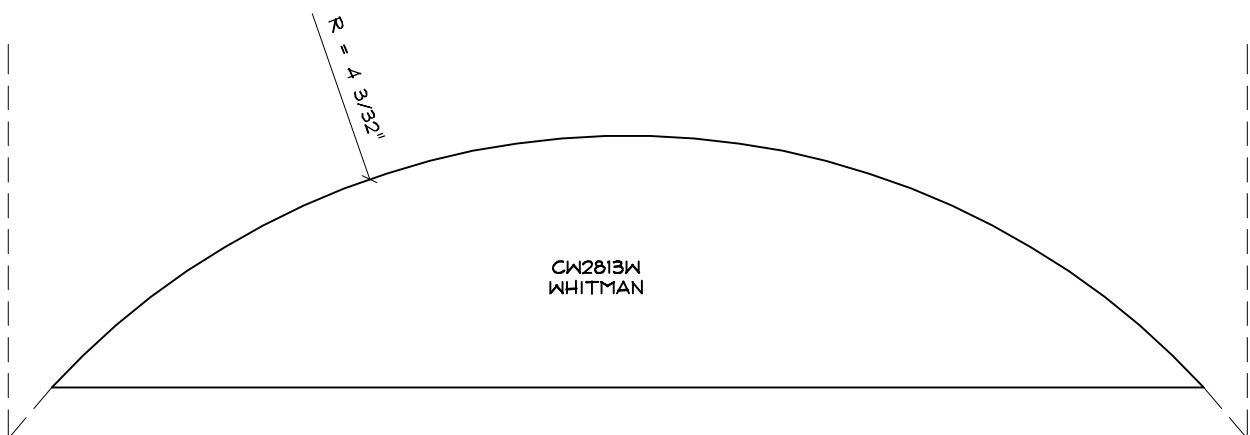
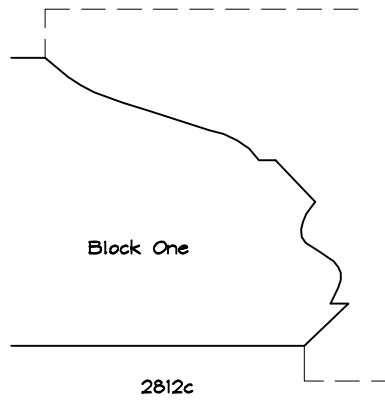
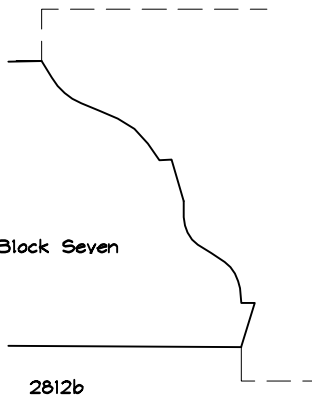
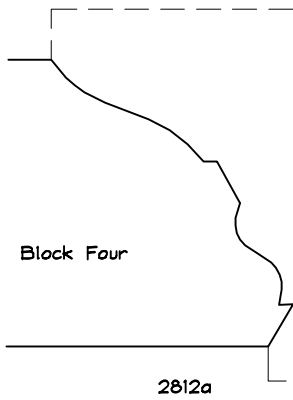
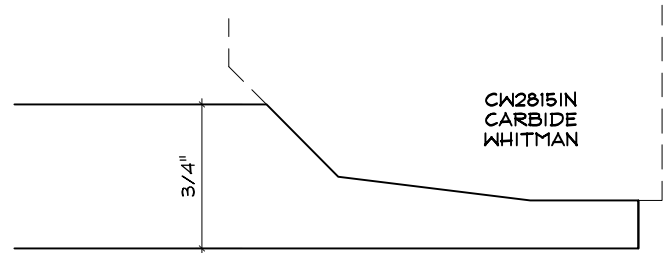
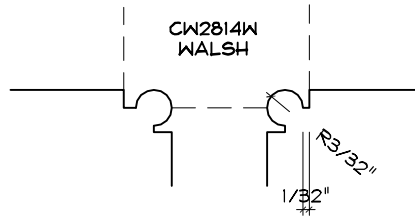
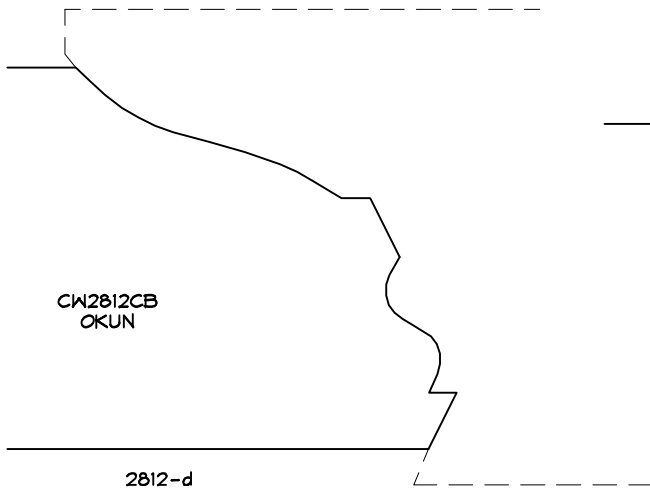
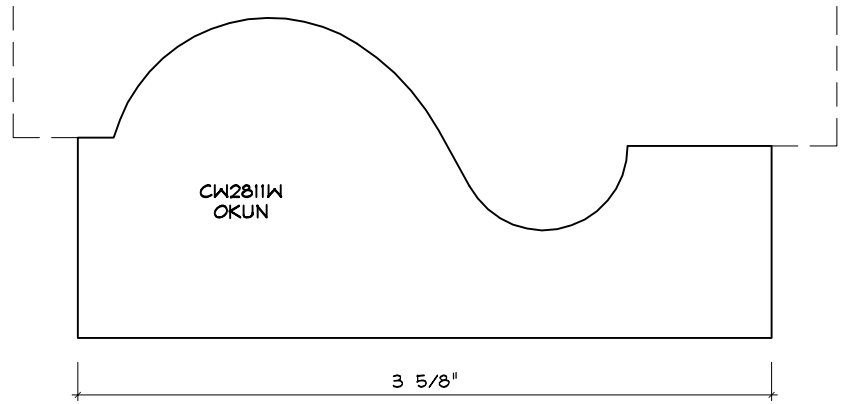
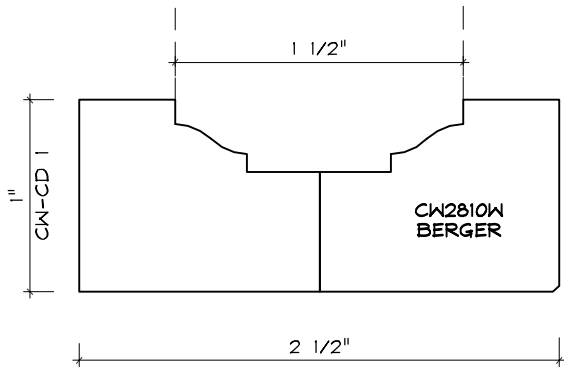

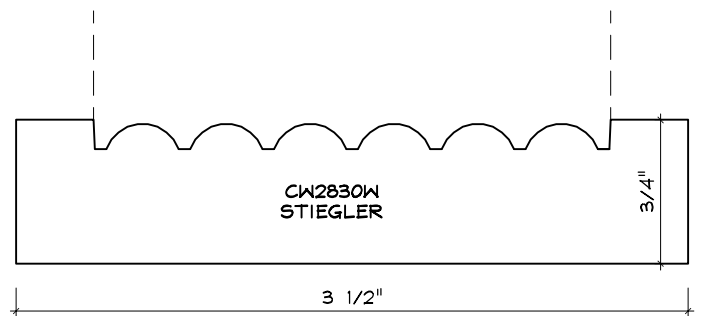
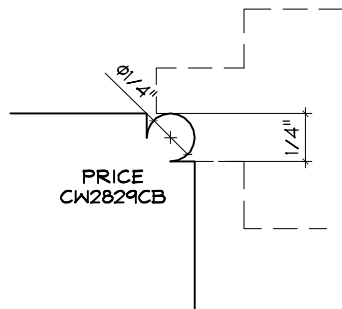
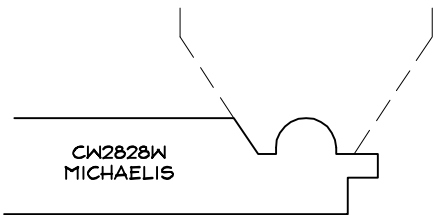
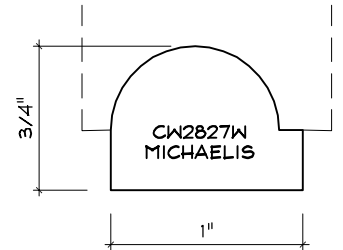
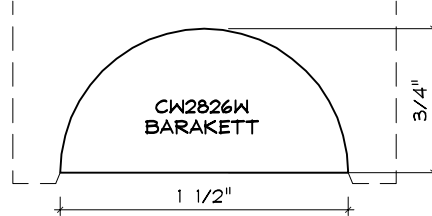
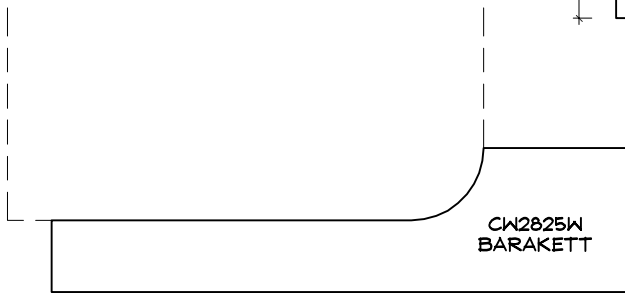
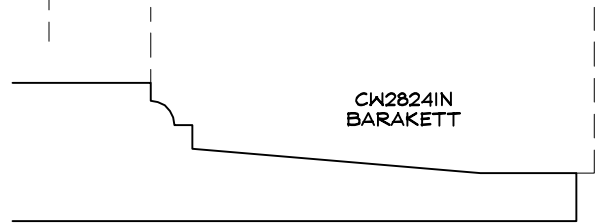
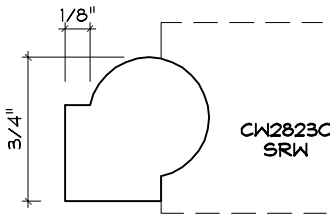
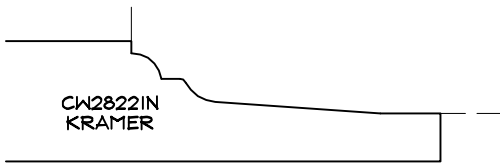
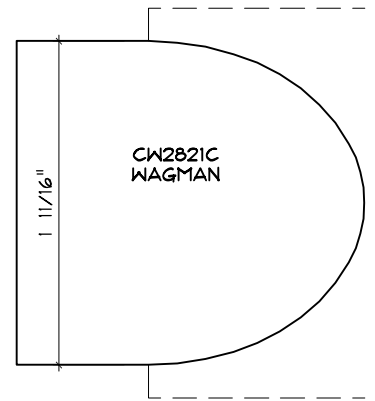
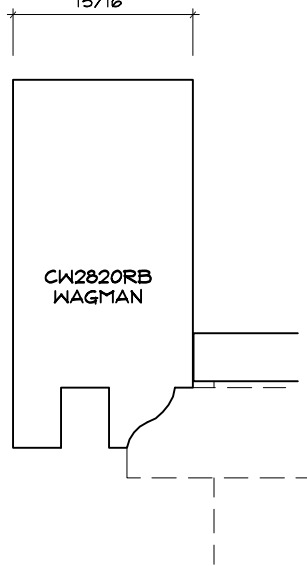
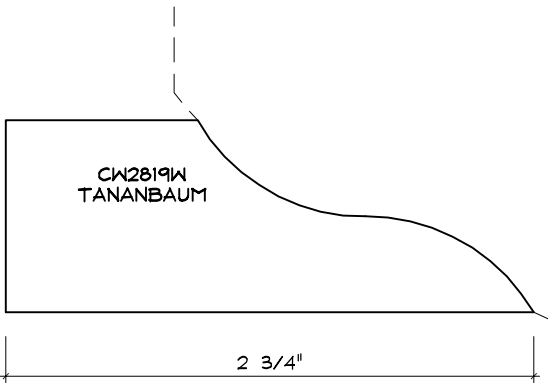
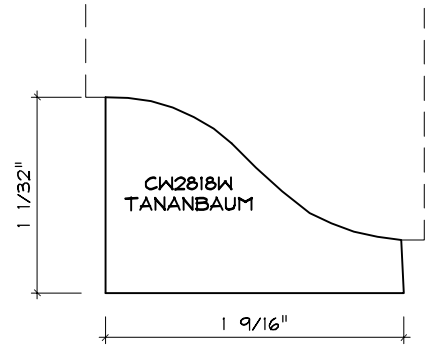
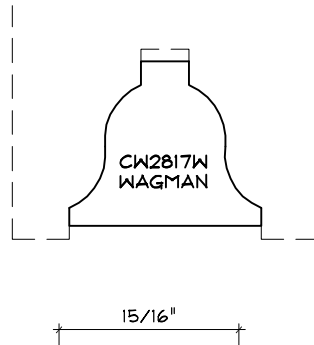
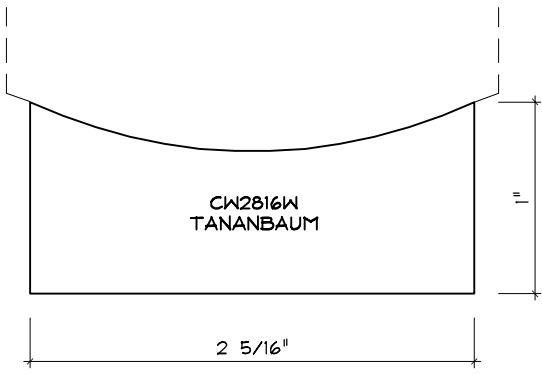

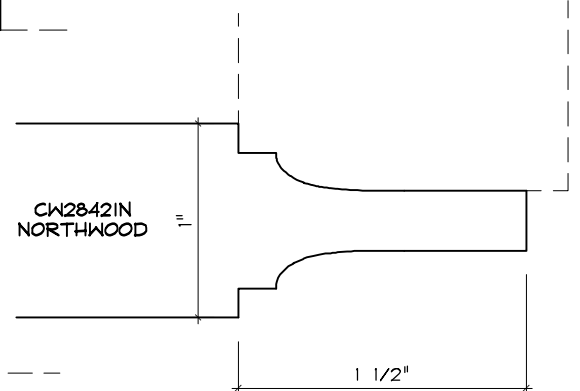
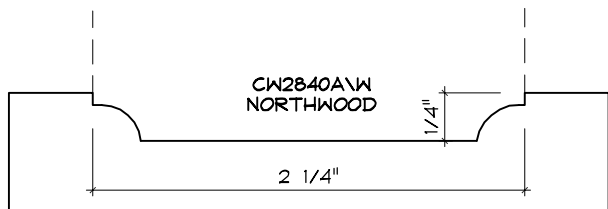
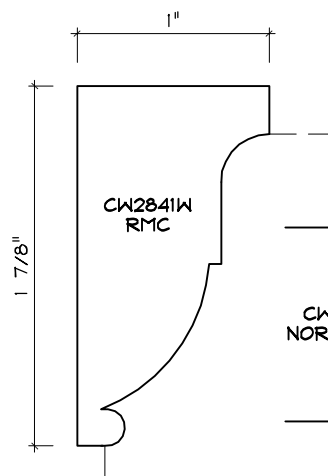
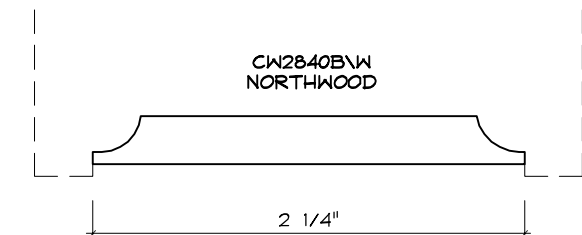
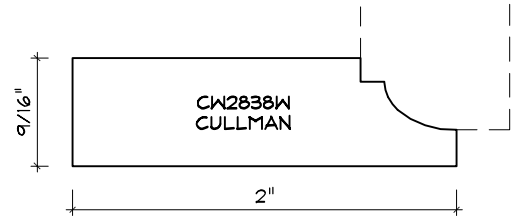
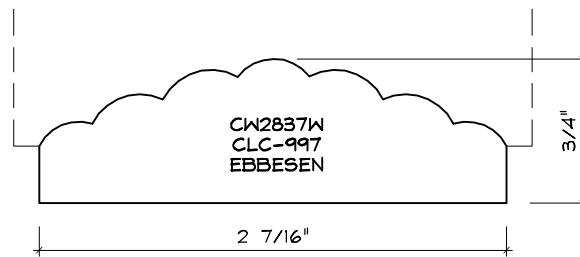
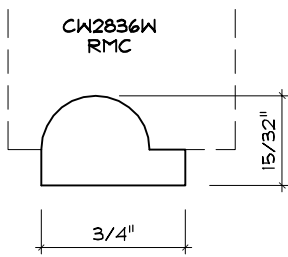
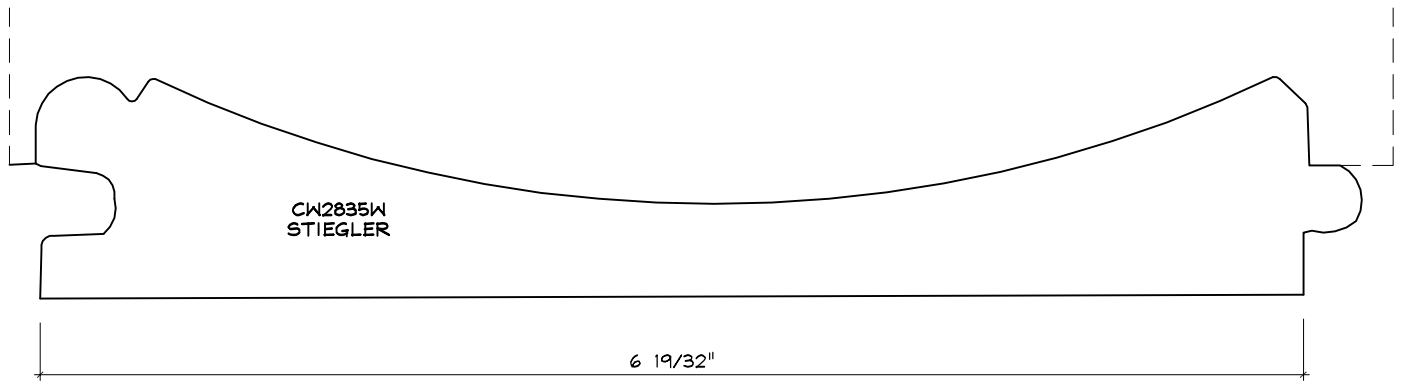
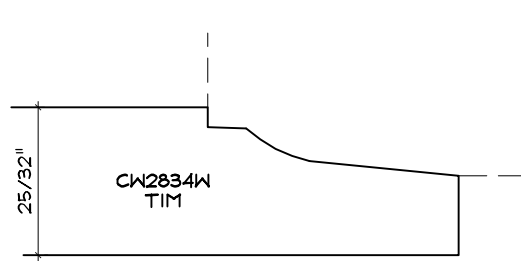
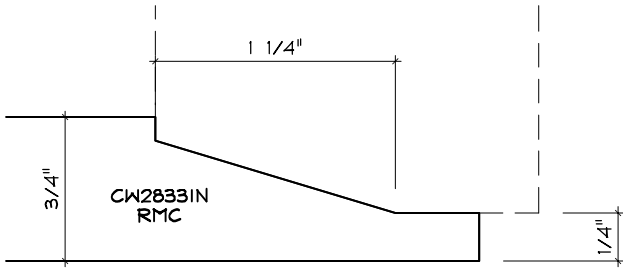
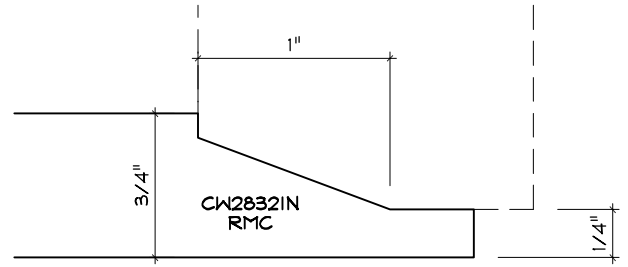
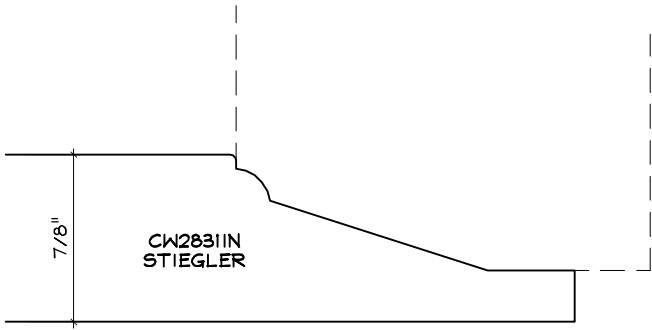

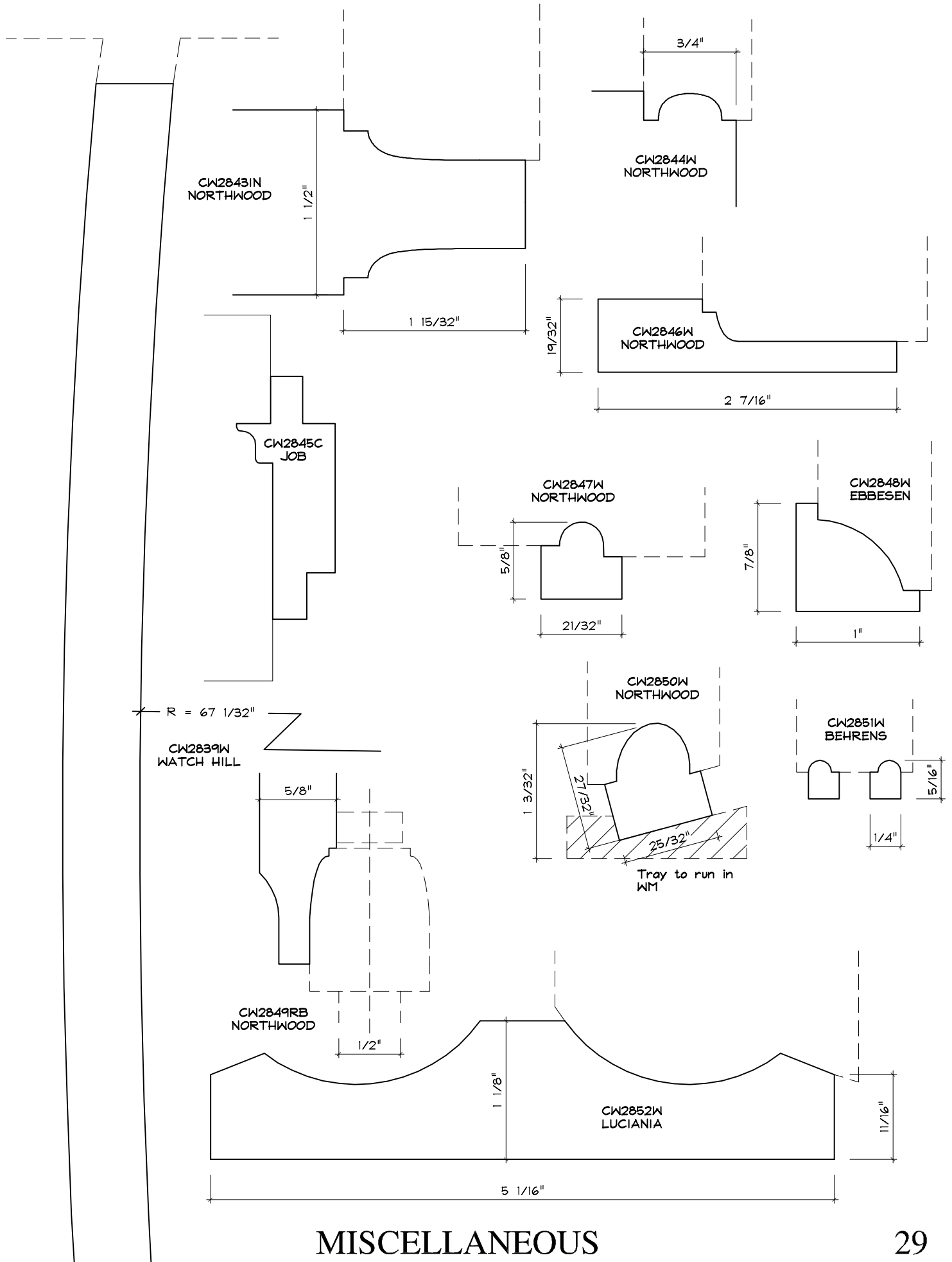

MISCELLANEOUS

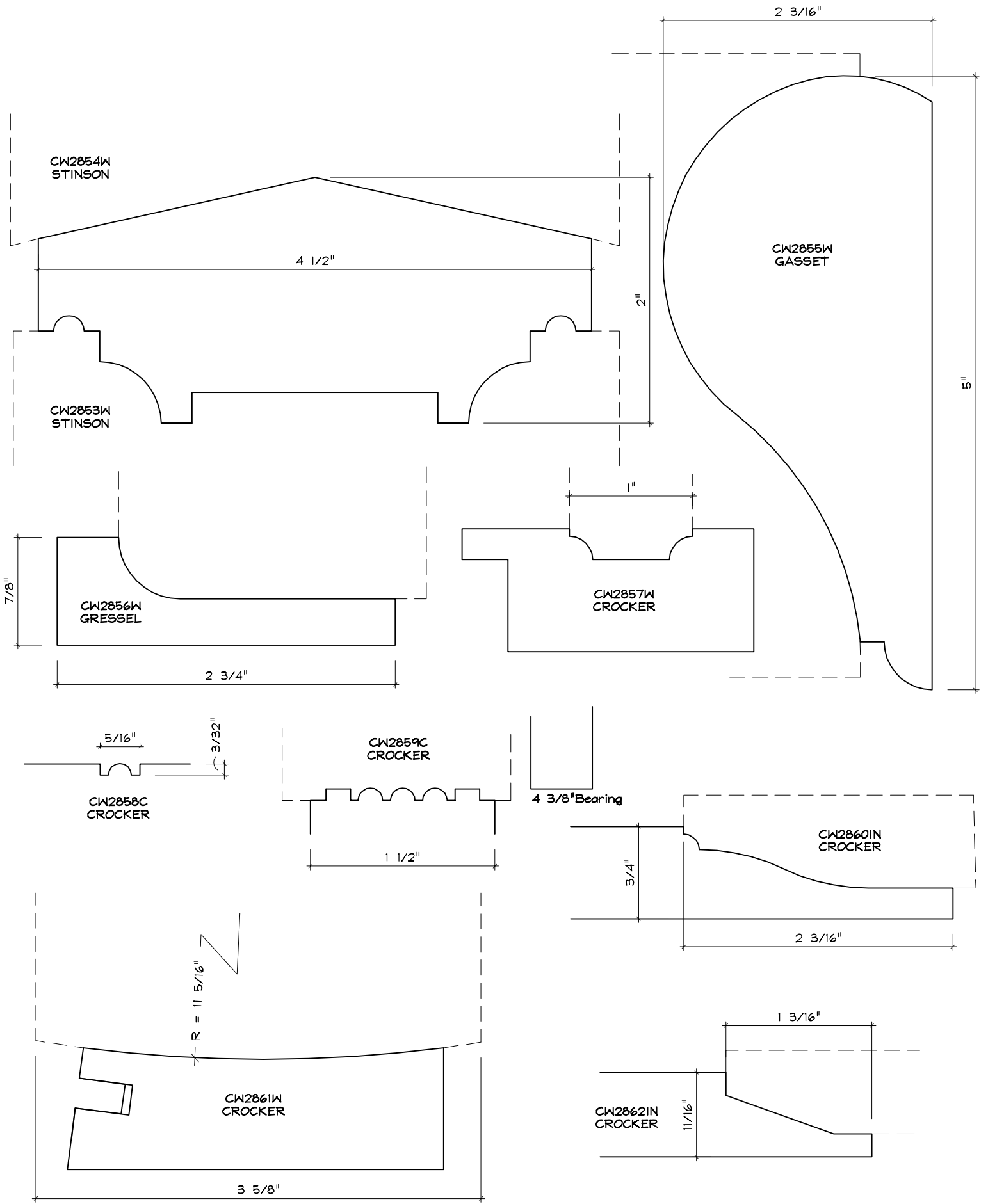

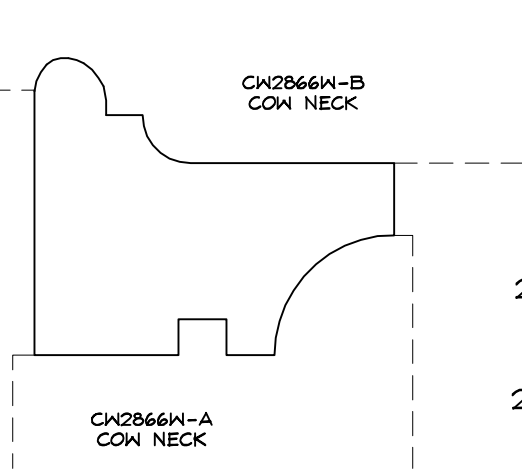
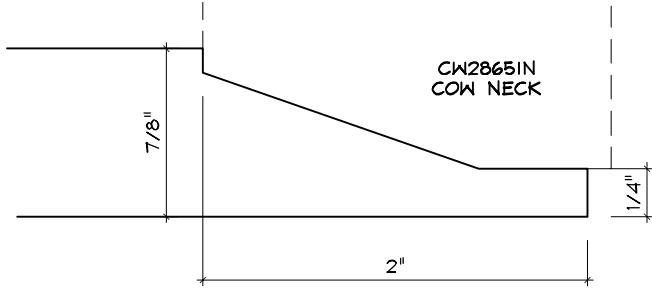
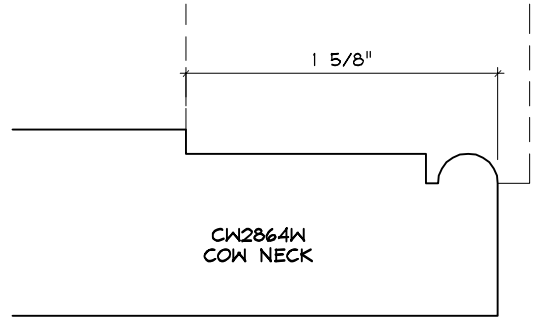
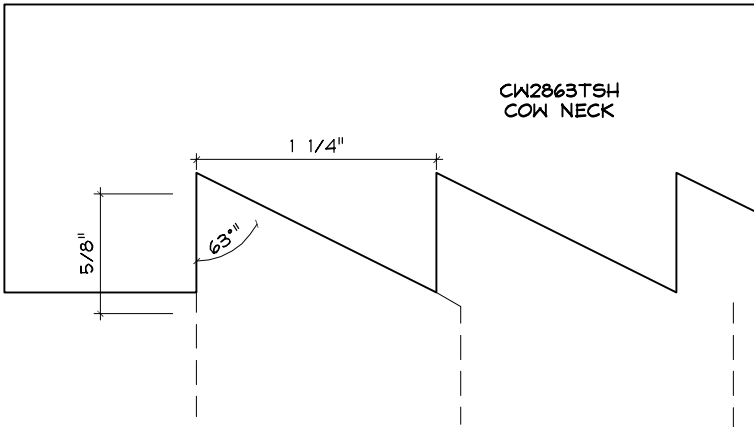

CW2866W-B
COW NECK

2867a wm

2867b wm